

V E R I N E
FIRES ✦ TO ✦ INSPIRE

Quasar HE

INSET LIVE FUEL EFFECT GAS FIRE

Installation, Maintenance & User Instructions

Hand these instructions to the user

Model No's NHKCMN, NHKC**SN, NHKC**RN, NHKP**MN, NHKP**SN & NHKP**RN are only for use on Natural Gas (G20) at a supply pressure of 20 mbar in G.B. / I.E.**

Model No. NHKCMP is for use on Propane Gas (G31) at a supply pressure of 37 mbar in G.B. / I.E.**

**** denotes cosmetic variant**

CONTENTS

	Information and Requirements	PAGE
Section 1		
1.0	Appliance Information	3
1.1	Conditions of Installation	4
1.2	Flue and chimney suitability	4
1.3	Fireplace / surround suitability	5
1.4	Shelf position	5
1.5	Chimney inspection	5-6
1.6	Fire place opening / catchment space	6-7
1.7	Fitting to Metal Flue Boxes	7
1.8	Fitting to Pre-Cast Flues	8
1.9	Spillage Monitoring System	8
1.10	Wall / Hearth Mounting	9
Section 2	Installation of Fire	
2.1	Unpacking the fire	9
2.2	Installing the fire box	9-18
2.3	Gas tightness and inlet pressure (MC models)	19
2.4	Gas tightness and inlet pressure (SC models)	20
2.5	Gas tightness and inlet pressure (RC models)	20
Section 3	Assembling Fuel Bed and Commissioning	
3.1	Assembling the ceramics and fuel bed (coal models)	20-24
3.2	Assembling the ceramics and fuel bed (pebble models)	25-29
3.3	Lighting the appliance (Manual Control model)	30-31
3.4	Lighting the appliance (Slide Control model)	31
3.5	Connecting the battery pack (Remote Control model)	32
3.6	Fixing the infra-red eye	33
3.7	Lighting the appliance (Remote Control model)	34
3.8	Fitting the trim / fret (Quasar models)	35
3.9	Fitting the one piece fascia (Frontier 3 models)	35
3.10	Fitting the one piece HITW fascia (Frontier 4 models)	35
3.11	Checking for clearance of combustion products	36
Section 4 & 5	Maintenance	
4.1	Removal of the Burner Assembly (Manual Control models)	37
4.2	Removal of the Piezo Igniter (Manual Control models)	38
4.3	Removal of the Control Tap (Manual Control models)	38
4.4	Removal of the Pilot Assembly (Manual Control models)	38-39
4.5	Removal of the Burner Assembly (Slide Control models)	40
4.6	Removal of the Battery Ignitor (Slide Control models)	40
4.7	Replacing the Battery (Slide Control models)	41
4.8	Removing the Oxy-Pilot Assembly (Slide Control models)	41
4.9	Replacing the Control Cable (Slide Control models)	42-43
5.1	Removal of the Burner Assembly (Remote Control models)	43
5.2	Removing the Remote Gas Valve	43
5.3	Removing the Oxy-Pilot Assembly (Remote Control models)	44
5.4	Repacing the Batteries (Remote Control models)	44
Section 6	User Instruction Section	
6.1	Conditions of Installation & About Your New Fire	46-47
6.2.1	Operating the fire (MC Models)	47
6.2.2	Operating the fire (SC Models)	48
6.2.3	Operating the fire (RC Models)	49
6.2.4	Remote handset malfunction	50
6.3	Re-assembling the ceramics and fuel bed (coal models)	51-55
6.4	Re-assembling the ceramics and fuel bed (pebble models)	56-60
6.5	Cleaning the Fire	60
6.6	Cleaning the Fuel-bed / Glass Panel	60-61
6.7	Removal & Re-Fitting the Trim / Fret / Fascia	61
6.8	User Replaceable Parts	61

SECTION 1 INFORMATION AND REQUIREMENTS

1.0 APPLIANCE INFORMATION

Model	NHKC/P**M/S/RN	NHKC**MP
Gas Type	G20	G31
Main injectors (2 off)	Size 130	Size 80
Pilot Type	Copreci 21100 / 141 (MC) Copreci 21100 / 162 (SC & RC)	SIT YA OP 9214 (MC)
Max. Gross Heat Input :	4.5 kW	4.5 kW
Min. Gross Heat Input :	3.5 kW	3.5 kW
Cold Pressure :	20.0 +/- 1.0 mbar	37.0 +/- 1.0 mbar
Ignition :	Push Button Piezo (MC models) 1.5V Battery Generator (SC models) 9V Battery Generator (RC models)	
Electrode Spark Gap	4.5mm Nominal	
Weight	Quasar 16.5kg	

Fire box Dimensions (with trim fitted)

Width :	(with standard trim, no spacer)	470mm
Height :	(with standard trim, no spacer)	586mm
Depth :	(overall-without fender)	180mm
Depth :	Flush-fit (from mounting face to rear)	180mm
Depth :	Flush-fit (mounting face to rear with 50mm spacer fitted)	130mm

Gas Connection 8mm Compression (Supplied with fire)

This appliance is manufactured by :-

BFM Europe Ltd, Trentham Lakes, Stoke-on-Trent, ST4 4TJ

Efficiency Declaration

The efficiency of this appliance has been measured as specified in BS 7977-1 : 2002 and the result is 70%. The gross calorific value of the fuel has been used for this efficiency calculation.

The test data from which it has been calculated has been certified by BSI.

The efficiency value may be used in the UK Government's Standard Assessment Procedure (SAP) for energy rating of dwellings.

INSTALLATION REQUIREMENTS

1.1 CONDITIONS OF INSTALLATION

It is the law that all gas appliances are installed only by a Registered Installer, in accordance with these installation instructions and the Gas Safety (Installation and Use) Regulations 1998 as amended. Failure to install appliances correctly could lead to prosecution. It is in your own interest and that of safety to comply with the law.

The installation must also be in accordance with all relevant parts of the Local and National Building Regulations where appropriate, the Building Regulations (Scotland Consolidation) issued by the Scottish Development Department, and all applicable requirements of the following British Standard Code of Practice.

1. BS 5871 Part 2 Installation of Inset Fuel Effect Gas Fires
2. BS 6891 Installation of Gas Pipework
3. BS 5440 Parts 1 & 2 Installation of Flues and Ventilation
4. BS 1251 Open fire place components
5. BS 715 / BS EN 1856-2 Metal flue pipes for gas appliances
6. BS 6461 Part 1 Installation of masonry chimneys and flues
7. IS 813 : 1996 Domestic Gas Installation (Republic of Ireland)

No purpose made additional ventilation is normally required for this appliance, when installed in G.B. When Installing in I.E. please consult document I.S. 813 : 1996 Domestic Gas Installation, which is issued by the National Standards Authority of Ireland. If installing in Northern Ireland, please consult local building regulations. In Scotland, please consult the current edition of the Building standards regulations, issued by the Scottish Executive. Any purpose made ventilation must be checked periodically to ensure that it is free from obstruction.

1.2 FLUE AND CHIMNEY SUITABILITY

This appliance is designed for use with conventional brick built or lined chimneys and fabricated flues and metal flue boxes conforming to BS 715 / BS EN 1856-2. All flues must conform to the following minimum dimensions.

Minimum diameter of circular flues	125 mm (Without Flue Restrictor Fitted)
Minimum effective height of all flue types	4 metres

When fitting to conventional chimneys or 175mm flues it may be desirable to fit the flue restrictor baffle (supplied) to reduce the flue flow and increase the efficiency of the fire. Safe clearance of products must always be checked by carrying out a smoke match test as described.

1.3 FIREPLACE / SURROUND SUITABILITY

The fire must only be installed on a hearth it **must not be installed directly onto carpet or other combustible floor materials**. The fire is suitable for fitting to non-combustible fire place surrounds and proprietary fire place surrounds with a temperature rating of at least 150⁰c. (Class "O")

If a heating appliance is fitted directly against a wall without the use of a fire surround or fire place all combustible material must be removed from behind the trim. Soft wall coverings such as blown vinyl, wall paper etc. could be affected by the rising hot air and scorching and / or discoloration may result. Due consideration should be made to this when installing or decorating.

1.4 SHELF POSITION

The fire may be fitted below a combustible shelf providing there is a minimum distance of 200mm above the top of the fire and the shelf does not project more than 150mm. If the shelf overhangs more than 150mm the distance between the fire and the shelf must be increased by 15mm for every 25mm of additional overhang over 150mm.

1.5 FLUE / CHIMNEY INSPECTION

Before commencing installation, a flue or chimney should be inspected to ensure that all the following conditions are satisfied.

1. Check that the chimney / flue only serves one fire place and is clear of any obstruction. Any dampers or register plates must be removed or securely locked in the open position.
2. Brick / stone built chimneys or any chimney or flue which has been used for an appliance burning fuel other than gas must be thoroughly swept. The base of the chimney / flue must also be thoroughly cleared of debris etc.
3. Any under-floor air supply to the fire place must be completely sealed off.
4. Ensure that the inside of the chimney / flue is in good condition along it's length and check that there is no leakage of smoke through the structure of the chimney during and after the smoke pellet test.
5. **Using a smoke pellet, check that there is an up-draught in the chimney / flue and that the smoke can be seen issuing from the terminal / chimney pot outside. There must be no leakage of smoke through the structure of the chimney during or after the smoke pellet test and it is important to check inside upstairs rooms adjacent to the chimney / flue.**

Check the chimney pot / terminal and general condition of the brickwork or masonry. If the chimney or flue is in poor condition or if there is no up-draught do not proceed with the installation. If there is a history of down-draught conditions with the chimney / flue, a tested and certificated flue terminal or cowl suitable for the relevant flue type should be considered.

6. **A spillage test must always be carried out during commissioning of the appliance.**

1.6 FIRE PLACE OPENING AND CHIMNEY CATCHMENT SPACE

The front opening of the fire place must be between 370 and 450 mm wide, and between 550 and 570mm high. If the opening exceeds these dimensions then a surround must be constructed from suitable non-combustible material to produce a correct size opening. Any surround must be suitably sealed to the fire place to prevent leakage. See below in fig.1

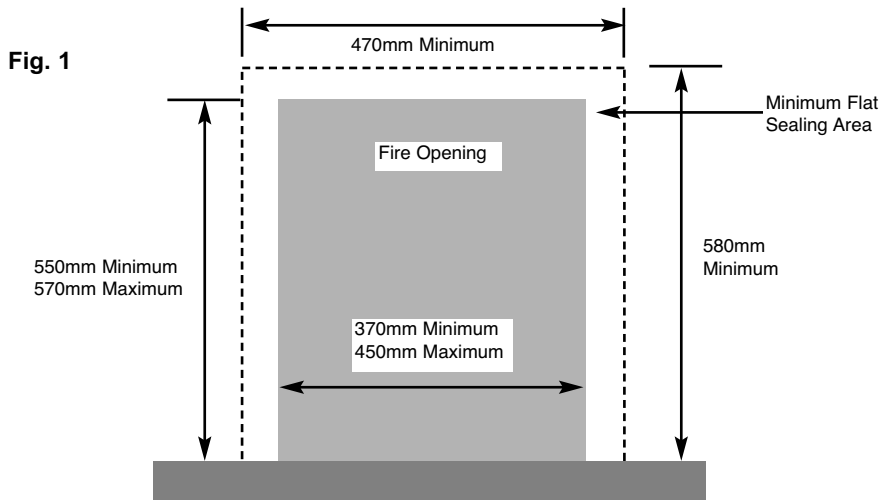

When installing into a brick built chimney, you must ensure that there is sufficient depth to accommodate any debris which may fall from the chimney. This depth must be sufficient to accommodate 12 litres of volumetric space.

Table A - Installation Depth Requirements for a Verine Quasar HE, being installed into a brick built chimney, requiring 12.0 litres of debris collection volume (fig. 2)

When installing this product into a brick built chimney, there must be a minimum depth available of 200mm available for the collection of debris behind the firebox when installed.

See fig. 2 below for explanatory diagram.

Fig. 2

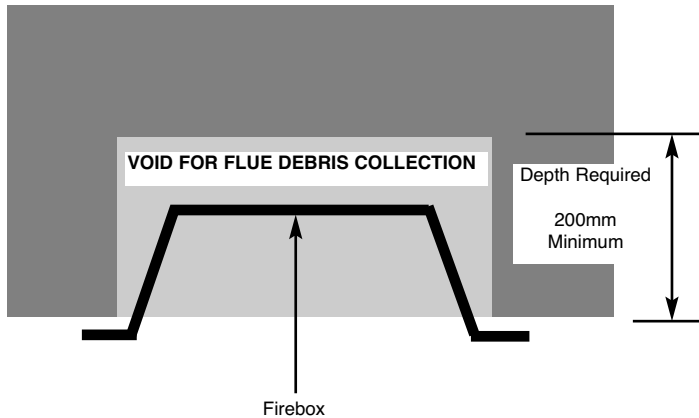

1.7 FITTING TO PRE-FABRICATED TWIN WALL METAL FLUE BOXES

The appliance may be fitted to twin wall metal flue boxes conforming to the constructional requirements of BS 715, (for example the Selkirk LFE 175 box). The box must have a minimum flue diameter of 125mm internal and minimum internal dimensions of 275mm deep by 580mm high by 400mm wide. The top face of the box must be insulated with a minimum thickness of 50mm of non-combustible mineral wool insulation or similar material. The flue box must stand on a non-combustible base of minimum thickness 12mm if the flue box being utilised is of single skin construction.

1.8 FITTING TO PRE-CAST FLUES

When installing this appliance into pre-cast flues, always ensure that the spigot restrictor baffle has been removed.

To install the fire box in to pre-cast flue starter blocks, there must be at least 180mm from the mounting face of the fire to the rear of the pre-cast flue starter block to allow sufficient space for debris collection. It is important to consider this depth when choosing a fire surround as the thickness of the fire surround must be sufficient to give a total depth of **at least 180 mm to the rear of the starter block**, otherwise there will be insufficient depth. The fire surround may be packed away from the wall using suitable non-combustible board, providing the installation is correctly sealed. If in doubt about the suitability of the fire contact the manufacturer for advice before proceeding. **This fire has been designed to fit standard 100mm pre-cast starter blocks with 3 inch rebated surrounds and a 10mm plaster wall covering.** It is important to ensure that the pre-cast flue is in good condition and is free from extruded mortar or sealant from between the flue blocks.

This appliance has been tested for use in a pre-cast flue block complying with BS EN 1858. In accordance with BS EN 1858, pre-cast flues built with directly plastered faces (front or rear) are not correctly installed as to ensure proper operation with any type of gas fire. In some instances of this flue construction, temperature cracking of surface plaster may occur through no fault of the appliance. An air gap or some form of insulation material should be installed to prevent normal flue temperatures from damaging wall surfaces.

1.9 SPILLAGE MONITORING SYSTEM

This appliance is fitted with an atmosphere sensing spillage monitoring system in the form of an oxygen sensing pilot. This is designed to shut the fire off in the event of a partial or complete blockage of the flue causing a build up of combustion products in the room in which the fire is operated. **The following are important warnings relating to this spillage monitoring system :-**

- 1) The spillage monitoring system must not be adjusted by the installer.
- 2) The spillage monitoring system must not be put out of operation.
- 3) When the spillage monitoring system is exchanged only a complete original manufacturers part may be fitted. It is not possible to replace individual parts on the pilot system on this appliance, only a complete pilot assembly (including the thermocouple) may be fitted.

1.10 WALL / HEARTH MOUNTING

This appliance must be fitted on a flat, non-combustible base of minimum thickness 12mm. In addition, a non-combustible hearth or physical barrier should be provided in front of the fire.

With “hole in the wall” type installations, where it may be desirable not to fit a hearth panel or physical barrier, the product may be installed in accordance with Document J of the building regulations so that every part of the flame or incandescent material is at least 225mm above the floor level. For the customers safety, and in accordance with BS 5871-2, the fitting of a hearth panel or physical barrier should be carried out. Should this advice not be followed however, please give consideration to the safety of the occupants in the room to which the appliance is installed.

Any hearth panel or physical barrier that is fitted should project a minimum of 300mm forwards from the fire opening and 150mm either side of the fire opening, as shown below in Fig. 3. Any physical barrier must be securely fixed and be of robust design.

Fig. 3

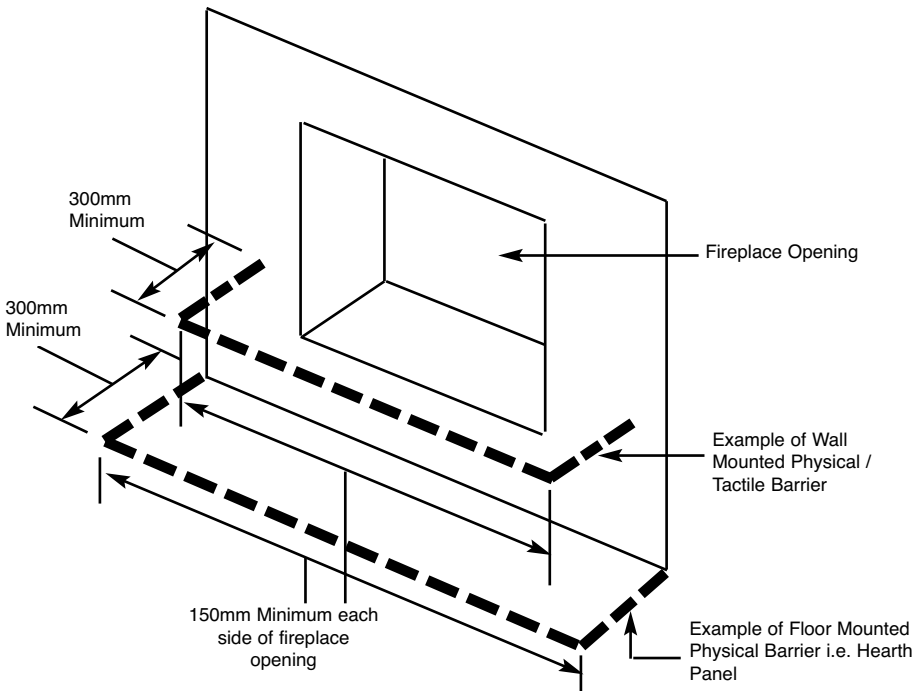

SECTION 2 INSTALLATION OF FIRE

2.1 UNPACKING THE FIRE

Carefully lift the fire out of the carton. Remove the loose item packaging carefully from the front of the appliance. Check the contents as listed :-

Packing Check List

1off	Fire box / burner assembly
1off	Boxed ceramic base, front ceramic rail and 11 large / 4 small coals or 13 pebbles (4 off "FR" pebbles 7 off "L" large & 2 off "S" small pebbles)
1off	Loose items bag including remote handset and 6AA batteries and 1 off 9V battery on RC models.
1off	Flue restrictor baffle
1off	Installation & Maintenance / User Instruction Book (Combined)

2.2 INSTALLING THE FIRE BOX

Establish which type of flue you are intending to install the fire in to :-

225 x 225mm (9 inch x 9 inch) brick built chimneys 175mm (7 inch) diameter lined brick or stone flue, insulated pre-fabricated metal flue box to BS 715 / BS EN 1856-2. When installing into 125mm (5 inch) diameter lined brick or stone flue, or insulated pre-fabricated metal flue box and liner to BS 715 / BS EN 1856-2 the restrictor baffle must not be fitted.

The flue restrictor baffle (supplied in the loose items) should only be used in 225 x 225mm (9 inch x 9 inch) brick built chimneys where the flue pull is excessive. It must not be fitted if installing the product into a metal flue box, pre-cast or 125mm diameter lined flue. See fig 4 / 5 below for details on fitting / removing the restrictor baffle onto the spigot on the rear of the firebox.



Fig 4 - Flue Restrictor Baffle Not Fitted

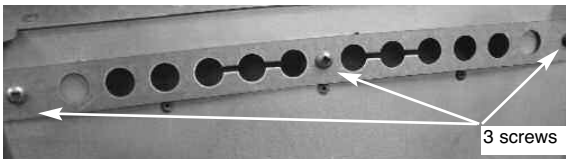

Fig 5 - Flue Restrictor Baffle Fitted via 3 screws as shown

A spillage test must always be carried out to check satisfactory clearance of flue products, regardless of the type of flue the appliance is being fitted to.

For all models proceed as follows :-

- a) Remove the top glass retaining cover from the product. It is secured via the two screws as indicated. See fig. 6 below.

Fig. 6

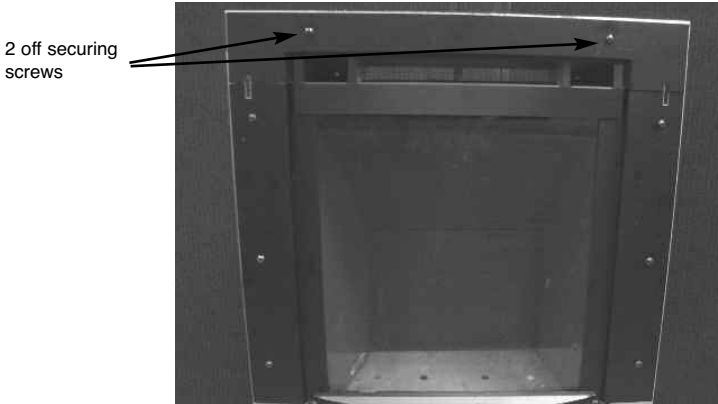

- b) Remove the left and right hand side glass securing brackets from the product. They are secured via 3 off screws each side. See fig. 7 below.

Fig. 7



- c) Lift the glass panel forwards and clear from the firebox, taking care not to damage the glass panel. See fig. 8 below

Fig. 8



- d) Remove the burner heat shield, which is retained by 2 off screws as shown below in fig. 9

Fig. 9

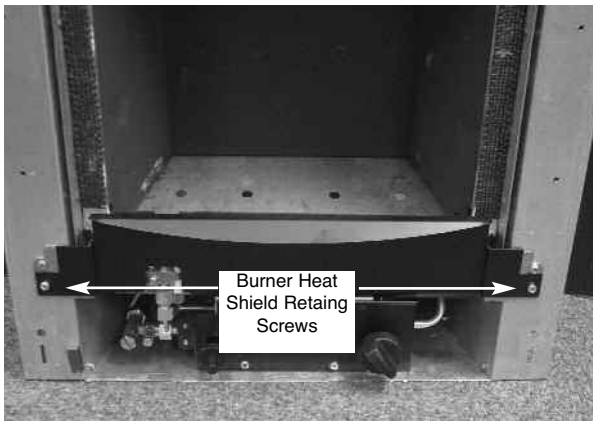

For all Manual Control models proceed as follows :-

- e) Remove the two off screws from the left and right hand burner mounting brackets, plus the two screws from the base of the control panel as shown below in Fig. 10, this will allow removal of the complete burner unit from the firebox.

Fig. 10

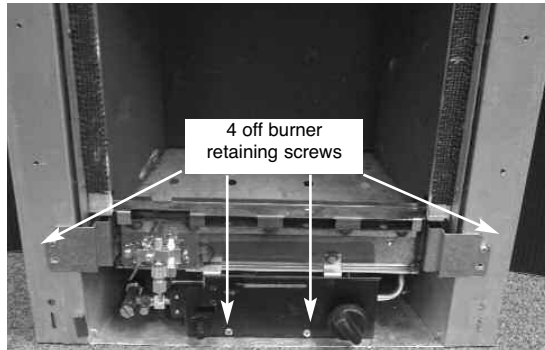

For all Remote Control models proceed as follows :-

- f) Remove the two off screws from the left and right hand burner mounting brackets, as shown below in Fig. 11, this will allow removal of the complete burner unit from the firebox.

Fig. 11

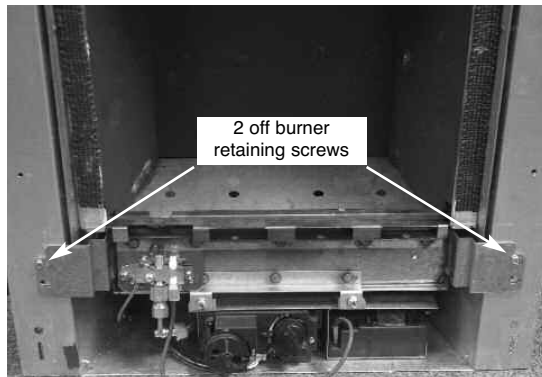

For all Slide Control models proceed as follows :-

- g) Remove the burner. To allow burner removal, the control lever operating cable must be removed. The control lever operating cable can be seen running across the base of the fire, below the burner. To release the cable, unscrew the cable securing screw located in the centre of the aluminium operating arm and pull the cable out from its fixing hole. Release the other end of the cable by pushing the cable forwards to the right, i.e. into the operating arm so as to release the tension. Pull the cable nipple out of the retaining hole and remove the cable through the slot in the operating arm. See fig. 12 below.

Fig. 12

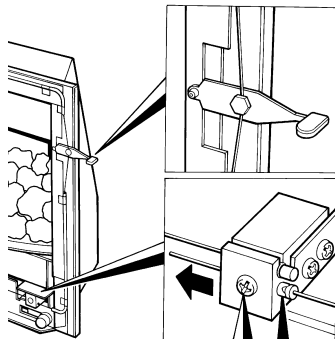

- h) Remove the two off screws from the left and right hand burner mounting brackets, plus the two screws from the base of the control panel as shown below in Fig. 13, this will allow removal of the complete burner unit from the firebox.

Fig. 13

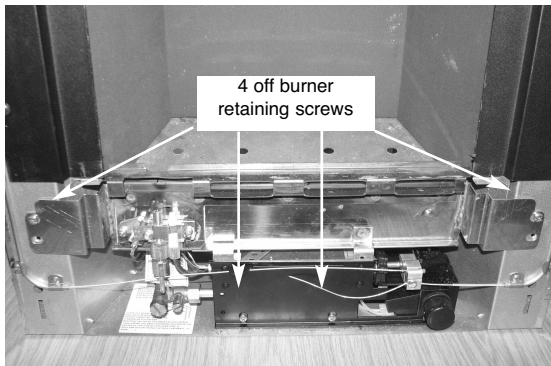

Continue for all models as follows :-

- i) Whilst the fire box is still in position, decide which side the gas supply is to enter the fire from. If concealed pipe work is required plan the pipe run to enter the fire box through one of the openings in the sides or rear of the fire box below the fuelbed support panel and connect to the isolating / inlet elbow. The gas connection to the appliance should be made to the isolating / inlet elbow using 8mm rigid tubing. There must be no soldered joints within the firebox. See fig. 14 & 15 below for suggested concealed pipe layouts.

Fig. 14

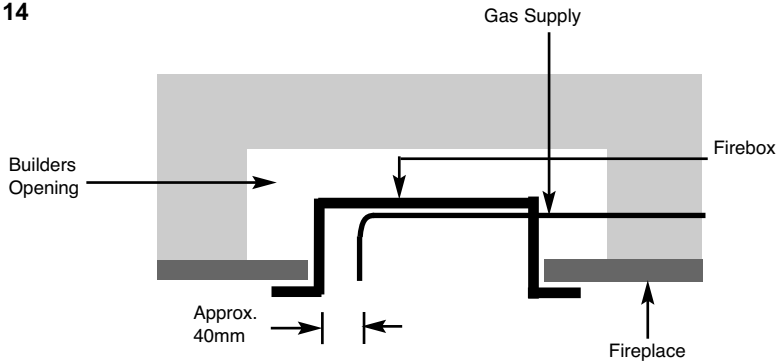
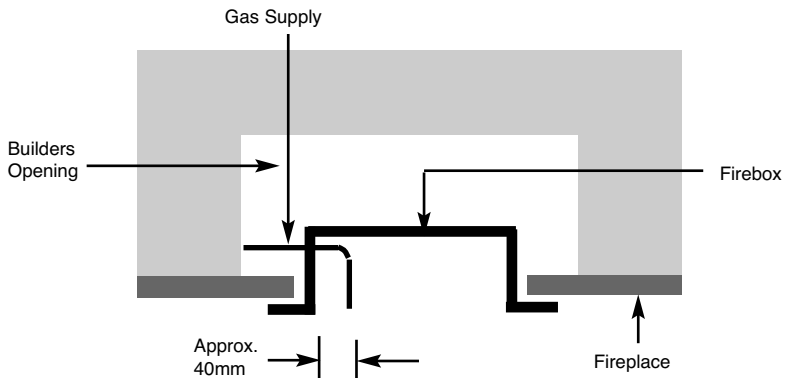

Fig. 15



Note : Before breaking into the gas supply a pressure drop test should be carried out to establish that the existing pipework is sound.

Carefully withdraw the fire box from the opening to enable the gas supply and fire fixing to be completed.

IMPORTANT : Sealing of the Gas Unused Gas Pipe Inlet Apertures

In line with current regulations, **it is imperative that the gas supply inlet apertures that are not utilised during the installation are sealed with the foil tape as supplied.** Failure to seal these inlet apertures could lead to flame reversal, which in turn will damage the burner and control systems of the product. Fig. 16 below shows a correctly sealed installation.

Fig. 16

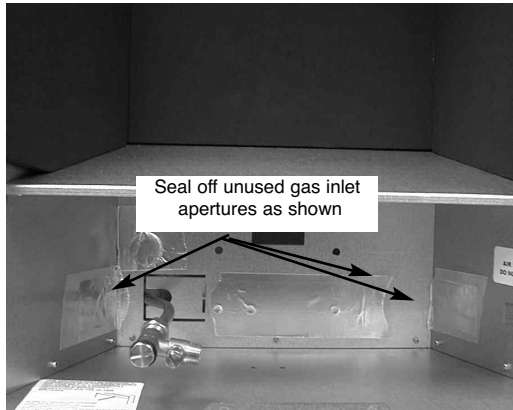

PLEASE NOTE :-

**BFM EUROPE LTD. WILL NOT BE LIABLE FOR
GUARANTEE CLAIMS THAT ARE AS A DIRECT
RESULT OF THE UNUSED GAS INLET APERTURES
NOT BEING CORRECTLY SEALED.**

The preferred method of fixing which is suitable for almost all situations is the cable fixing method which is described in the following section in detail.

To fit using the **preferred** cable method proceed as follows-

- j) Mark out and drill 4 off No 14 (6mm) holes in the back face of the fire opening in the positions shown below in fig. 17.

Fig. 17

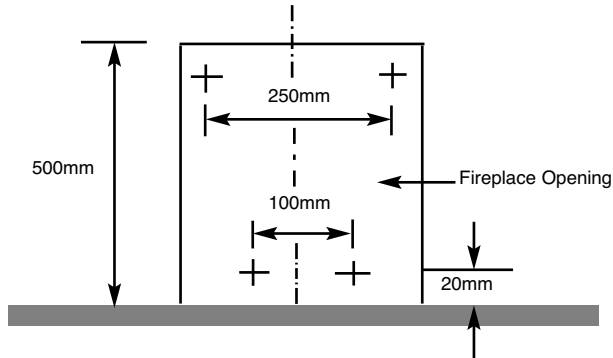

Fit the wallplugs provided and screw the fixing eyes securely into the rear of the fire opening. If the clearance at the rear of the fire is at the minimum specified for a precast flue application, it may be necessary to bend over the lower fixing eyes after screwing them fully in to the rear of a pre-cast starter block.

- k) Uncoil the two fire fixing cables and thread one end of each of the cables through one of the two holes on each side of the flue outlet shroud.
- l) Position the fire carefully on the (protected) surface of the hearth and reach into the fire opening. Thread each of the cables vertically downwards through the pair of fixing eyes on the same side of the fire. Thread the free end of the cables through the corresponding circular hole on each side of the lower rear of the fire. Carefully slide the fire box back into the fire opening and pull both cables tight.
- m) Thread a tensioning screw over each of the cables and ensure that the tensioning nut is screwed fully up against the hexagon shoulder of the tensioning screw (this provides maximum travel for the tensioning nut).
- n) Fit a screwed nipple on to each of the cables and pull hand tight up against the tensioning screw, then secure each nipple with a flat bladed screwdriver. See fig. 18 overpage.

Fig. 18

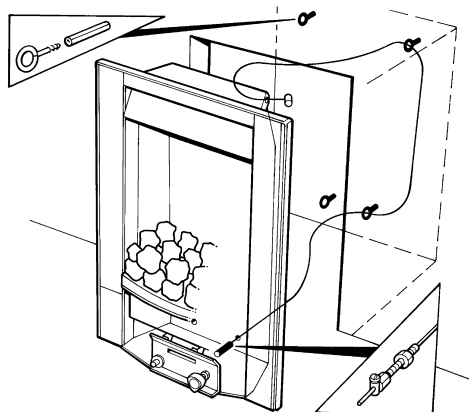

- o) Evenly tighten the tensioning nuts to tension both cables and pull the fire snugly against the wall. Do not overtighten, it is only necessary to pull the seal up against the sealing face of the wall, it does not need to be compressed. Check that there are no gaps behind the seal.
- p) With the fire securely in place, if a concealed gas connection has been made through either of the access holes in the sides of the fire, the holes should be closed around the pipe to prevent leakage of air through the gap around the pipe.
- q) Refit the burner. Fit the four retaining screws on manual control models or two screws on Remote control models and check that the burner is correctly locked into position.
- r) Refit the front burner heat shield to the sides of the fire box (2 Screws) and secure the trim to the fire using the magnets provided.
- s) **Before making the final gas connection, thoroughly purge the gas supply pipework to remove all foreign matter, otherwise serious damage may be caused to the gas control valve on the fire.**

The other firebox fixing method is as follows :-

In installations where the cable method is not suitable (e.g. loose masonry in rear of fire opening) the firebox can be secured to the fire surround using four screws and wall plugs provided. Below (fig. 19) is a diagram to indicate the hole centre positions available on the firebox to facilitate the screw fixing to the fireplace / surround.

Fig. 19

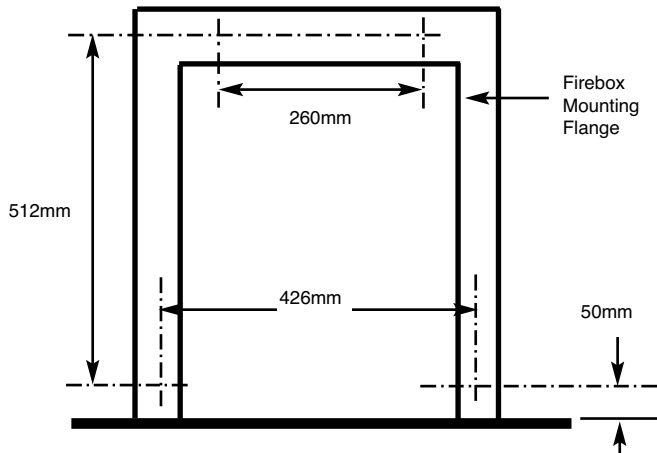

2.3 GAS TIGHTNESS AND INLET PRESSURE (MANUAL CONTROL MODELS)

- a) Remove the pressure test point screw from the inlet elbow and fit a manometer.
- b) Turn on the main gas supply and carry out a gas tightness test.
- c) Depress the control knob and turn anti-clockwise to the position marked pilot. Hold in the control knob for a few seconds to purge the pipe work then press the igniter button. The burner should light, continue to hold the control knob for a few seconds then turn to the full-on position.
- d) Check that the gas pressure for Natural Gas (G20) models is **20.0 mbar (+/- 1.0mbar) 8.0 in w.g.(+/- 0.4 in w.g.)** or for Propane Gas (G31) models **37.0 mbar (+/- 1.0mbar) 14.4 in w.g.(+/- 0.4 in w.g.)**
- e) Turn off the fire, remove the manometer and refit the pressure test point screw. Check the pressure test point screw for gas tightness with the appliance turned on using a suitable leak detection fluid or detector.

2.4 **GAS TIGHTNESS AND INLET PRESSURE (SLIDE CONTROL MODELS).**

- a) Remove the pressure test point screw from the pressure test point and fit a manometer.
- b) Turn on the main gas supply and carry out a gas tightness test.
- c) Depress the control lever to the position marked pilot. Hold down the control lever for a few seconds to purge the pipe work. The burner should light, continue to hold the control lever for a few seconds to latch the valve then lift to the full-on position.
- d) Check that the gas pressure for Natural Gas (G20) models is **20.0 mbar (+/- 1.0mbar) 8.0 in w.g.(+/- 0.4 in w.g.)**
- e) Turn off the fire, remove the manometer and refit the pressure test point screw. Check the pressure test point screw for gas tightness with the appliance turned on using a suitable leak detection fluid or detector.

2.5 **GAS TIGHTNESS AND INLET PRESSURE (REMOTE CONTROL MODELS).**

- a) Remove the pressure test point screw from the inlet elbow and fit a manometer.
- b) Turn on the main gas supply and carry out a gas tightness test.
- c) Depress both the round buttons on the handset. The fire will then commence its ignition sequence and will light to high. See page 30 to 34 for full details of the operating method for the fire.
- d) Check that the gas pressure is **20.0 mbar (+/- 1.0mbar) 8.0 in w.g.(+/- 0.4 in w.g.)**
- e) Turn off the fire, remove the manometer and refit the pressure test point screw. Check the pressure test point screw for gas tightness with the appliance turned on using a suitable leak detection fluid or detector.

SECTION 3 ASSEMBLING FUEL BED AND COMMISSIONING

3.1 ASSEMBLING THE CERAMICS AND FUEL BED - COAL MODELS

- a) Place the ribbed ceramic fuelbed base on top of the fuelbed support and pull fully forwards to the burner. **Make sure that the fuelbed base is located centrally in the fire box. Ensure that the fuelbed base fit fully down onto the fuel bed support and is not lodged on the burner. Ensure the air ports as indicated by the arrows are not blocked by the fuel-bed matrix.** See fig. 20 & 21 below.

Fig. 20

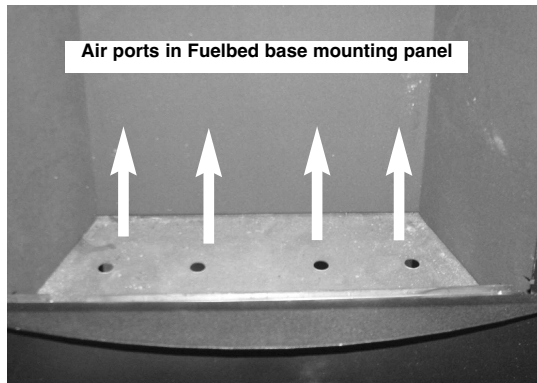
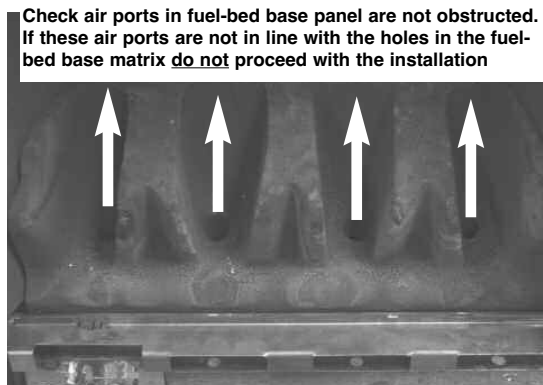

Fig. 21



NOTE : The position of the fuel-bed components are critical to the performance of the product. Therefore please ensure that the fuel-bed components are positioned as described in the following section prior to requesting a service call due to soot build up, poor flame pattern etc.

- b) Position the front ceramic coal support onto the burner support as shown below in Fig. 22

Fig. 22

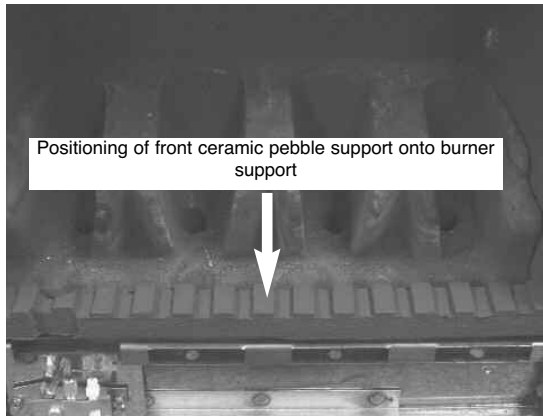

- c) Fit three large coals and one rectangular coal between the front rail and the fuel-bed matrix as shown below in Fig. 23.

Fig. 23



- d) Fit two small coals at the end of the row as shown below in Fig. 24.

Fig. 24



- e) Fit three large coals behind the front row, using the ribs in the fuel-bed base as a guide for placement as shown below in Fig. 25.

Fig. 25

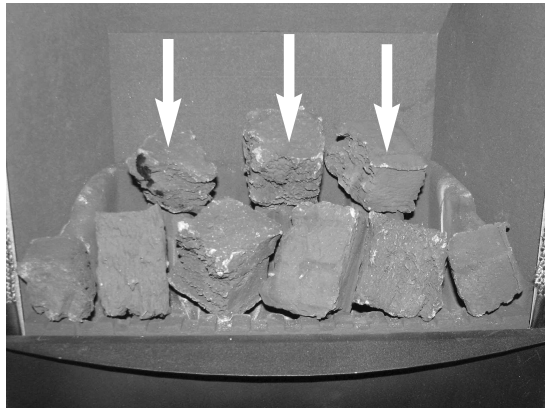

- f) Fit two small coals at the end of the row as shown below in Fig. 26.

Fig. 26

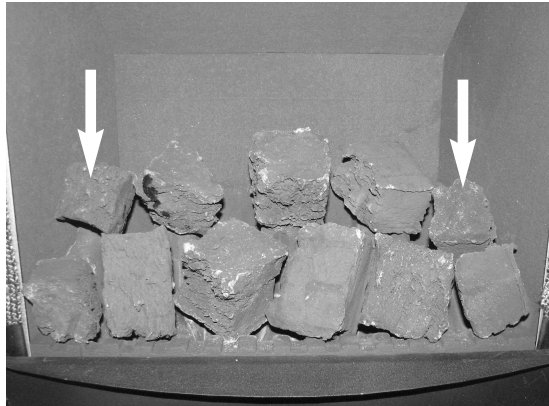

- g) Fit the remaining 4 large coals as shown below in Fig. 27

Fig. 27

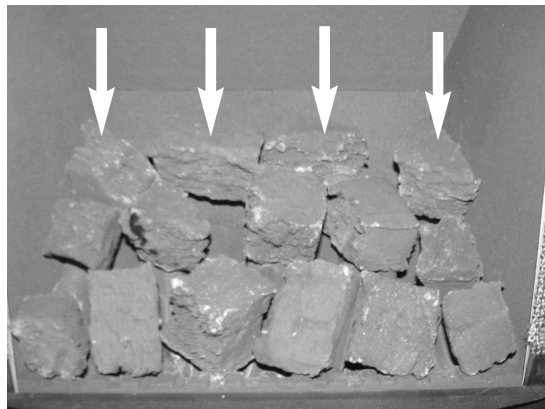

The exact position and fit of the coals may be very finely adjusted to give the most pleasing and random appearance.

Warning : Use only the coals supplied with the fire. When replacing the coals remove the old coals and discard them. Fit a complete set of coals of the correct type. Do not fit additional coals or any coals other than a genuine replacement set.

To ensure that the release of fibres from these R.C.F (Refractory Ceramic Fibre) articles is kept to a minimum, during installation and servicing we recommend that you use a HEPA filtered vacuum to remove any dust accumulated in and around the appliance before and after working on the appliance. When replacing these articles we recommend that the replaced items are not broken up, but are sealed within heavy duty polythene bags, clearly labelled as “RCF waste”. RCF waste is classed as a “stable”, non reactive hazardous waste and may be disposed of at a landfill licensed to accept such waste Protective clothing is not required when handling these articles, but we recommend you follow the normal hygiene rules of not smoking, eating or drinking in the work area, and always wash your hands before eating or drinking.

h.) Replace the glass panel and retaining trims as described on pages 11 & 12

NEVER USE THE FIRE WITHOUT THE GLASS PANEL IN POSITION, OR IF BROKEN OR CRACKED.

3.1 ASSEMBLING THE CERAMICS AND FUEL BED - PEBBLE MODELS

- a) Place the ribbed ceramic fuelbed base on top of the fuelbed support and pull fully forwards to the burner. **Make sure that the fuelbed base is located centrally in the fire box. Ensure that the fuelbed base fit fully down onto the fuel bed support and is not lodged on the burner. Ensure the air ports as indicated by the arrows are not blocked by the fuel-bed matrix.** See fig. 28 & 29 below.

Fig. 28

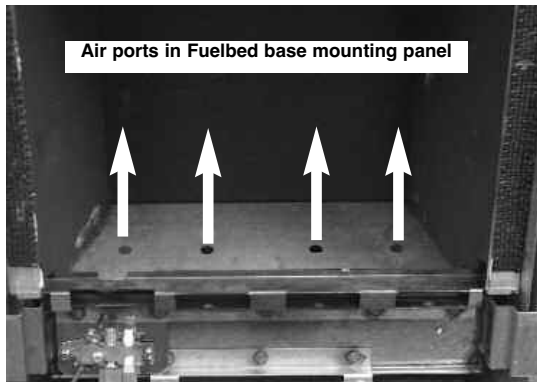
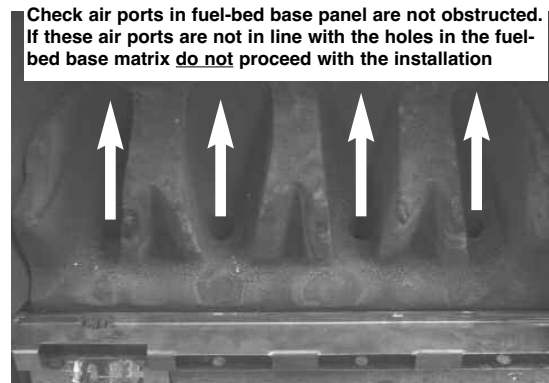

Fig. 29



NOTE : The position of the fuel-bed components are critical to the performance of the product. Therefore please ensure that the fuel-bed components are positioned as described in the following section prior to requesting a service call due to soot build up, poor flame pattern etc.

- b) Position the front ceramic pebble support onto the burner support as shown below in Fig. 30

Fig. 30

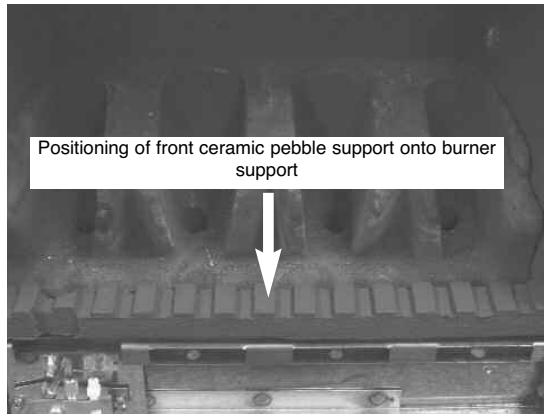

- c) Fit four of the specially shaped pebbles as shown below in fig 31. Ensure that the cut-out in the rear face of the pebbles is positioned as indicated. The 4 off specially shaped pebbles are packed in a bag with a label "FR" on them.

Fig. 31

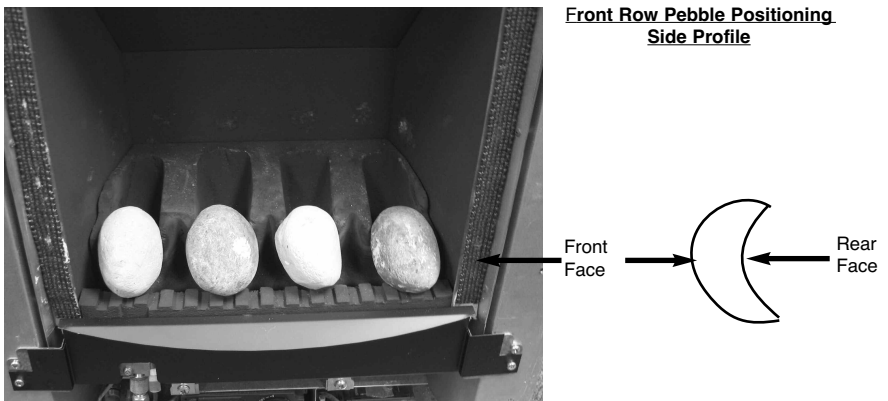

- d) Select three of the large pebbles and position on the three central ribs in the fuelbed as indicated in Fig. 32 below.

Fig. 32

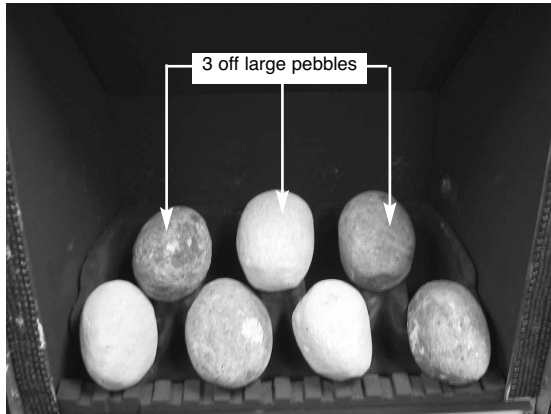

- e) Select the two small pebbles and arrange along the second row of the fuelbed. (See fig. 33 below)

Fig. 33

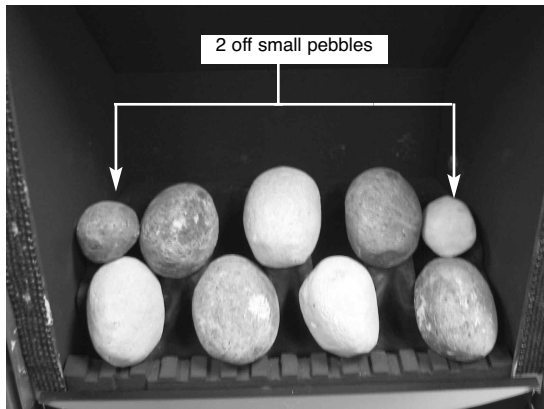

- f) Select the four remaining large pebbles and position as shown along the rear of the fuel-bed base in fig. 34 below.

Fig. 34

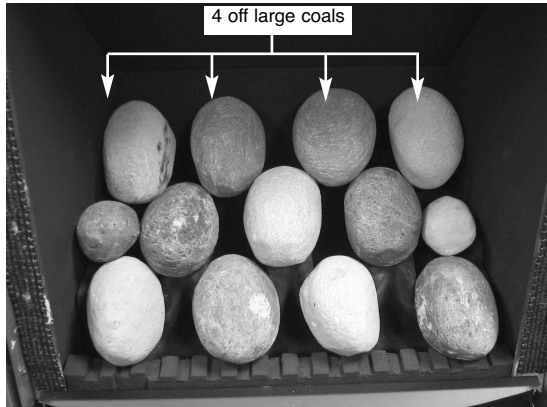

- g) Do a final check that the pebbles are layed out as shown below in Fig. 35

Fig. 35

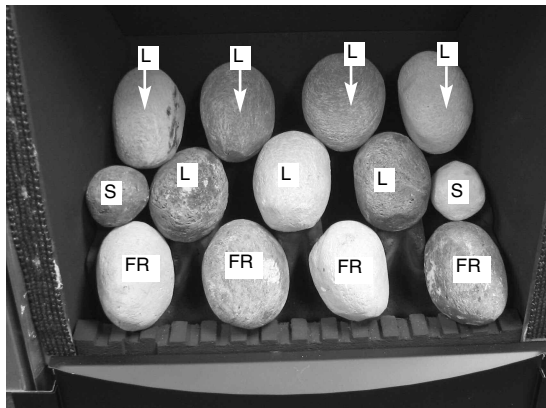

The exact position and fit of the pebbles may be very finely adjusted to give the most pleasing and random appearance.

Warning : Use only the pebbles supplied with the fire. When replacing the pebbles remove the old pebbles and discard them. Fit a complete set of pebbles of the correct type. Do not fit additional pebbles or any pebbles other than a genuine replacement set.

To ensure that the release of fibres from these R.C.F (Refractory Ceramic Fibre) articles is kept to a minimum, during installation and servicing we recommend that you use a HEPA filtered vacuum to remove any dust accumulated in and around the appliance before and after working on the appliance. When replacing these articles we recommend that the replaced items are not broken up, but are sealed within heavy duty polythene bags, clearly labelled as “RCF waste”. RCF waste is classed as a “stable”, non reactive hazardous waste and may be disposed of at a landfill licensed to accept such waste Protective clothing is not required when handling these articles, but we recommend you follow the normal hygiene rules of not smoking, eating or drinking in the work area, and always wash your hands before eating or drinking.

h.) Replace the glass panel and retaining trims as described on pages 11 & 12.

NEVER USE THE FIRE WITHOUT THE GLASS PANEL IN POSITION, OR IF BROKEN OR CRACKED.

3.3 LIGHTING THE APPLIANCE (Manual Control Models)

- a) Turn on the gas isolation tap.
- b) Depress the control knob and turn anti-clockwise to the position marked pilot. Hold in the control knob for a few seconds to purge the pipe work.
- c) Continue to hold-in the control knob and press the igniter button. If the burner does not light, continue to press the igniter button until ignition occurs. Continue to hold the control knob for 5-10 seconds to allow the thermocouple to heat up, if the pilot goes out when the control knob is released, repeat the lighting sequence.
- d) Turn the control knob in the anti-clockwise direction to the high position and the main burner will light. Leave in the high position for 10 mins until the fire has warmed up, then adjust as necessary to give the required heat output.
- e) Turn the control knob clockwise to the low position and the gas input will be reduced to the minimum setting.

- f) Slightly depress the control knob and turn to the pilot position, the main burner will go out but the pilot will remain lit.
- g) Slightly depress the control knob and turn to the off position, the pilot will now be extinguished.

WARNING : If the fire goes out for any reason or is turned off and it is necessary to re-light the fire it is important to allow the fire to cool for 3 minutes before attempting to re-light it.

3.4 LIGHTING THE APPLIANCE (Slide Control Models)

- a) Turn on the isolation valve. Depress the control lever fully downwards to the position marked " Z". Hold down the control lever for a few seconds to allow the gas to reach the pilot.
- b) The fire will then begin its ignition sequence. If the pilot does not light, continue to press the control lever until ignition occurs. The pilot flame can be seen by looking underneath the front ceramic rail, above the burner heat shield, at the front left hand side of the fuel. When the pilot has lit, continue to hold the control lever down for 5-10 seconds to allow the thermocouple to heat up, before releasing the lever apply one firm downwards push to ensure that the f.s.d. valve is fully latched, if the pilot goes out when the control lever is released, repeat the lighting sequence.
- c) After lighting, move control lever up to the high position and the main burner will light. It is recommended that for the most efficient performance the fire is allowed to warm up for 10 minutes with the control lever set to high.
- d) The gas control can be moved from the High to Low position to give the desired heat output.
- e) To turn the fire off, FULLY raise the control lever to the OFF position.

WARNING : If the fire goes out for any reason or is turned off and it is necessary to re-light the fire it is important to allow the fire to cool for 3 minutes before attempting to re-light it.

3.5 CONNECTING THE BATTERY PACK (Remote Control Models)

- a) To prevent un-necessary battery drain, the battery pack that is used to provide the remote control function for this product is disconnected at the factory. Prior to attempting to light the product, can the installer please ensure that the battery pack is re-connected as shown in section b) & c) below.
- b) Locate the battery pack in the support cradle at the bottom R/H side of the firebox / burner assembly.
- c) The wire and connecting plug from the battery pack should then be connected into the supply wire running from the control board. See Fig 36 below.

Fig. 36

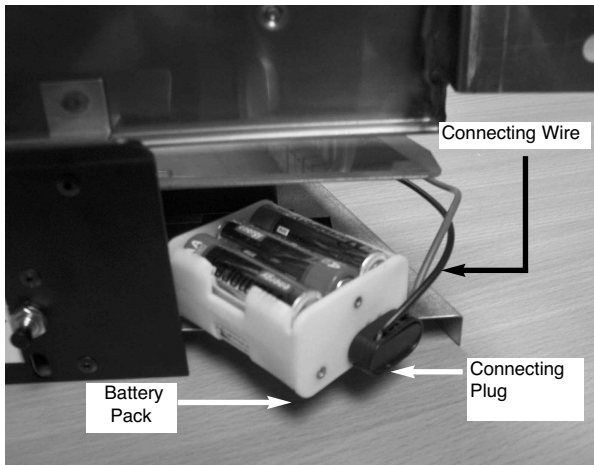

Note : Ensure that the battery pack is re-fitted correctly into it's mounting cradle

3.6 FIXING THE INFRARED SENSOR IN POSITION (Remote Control Models)

- a) Due to the large amount of different fascia's that can be supplied with these fires, the infrared sensor is supplied from the factory attached to a self adhesive pad. This pad can therefore be attached to the hearth in a position to suit the form of the fret or contemporary trim assembly that is chosen with the product. Fig. 37 below shows the self adhesive pad and infrared eye attached to the flying lead, as supplied from the factory.

Fig. 37

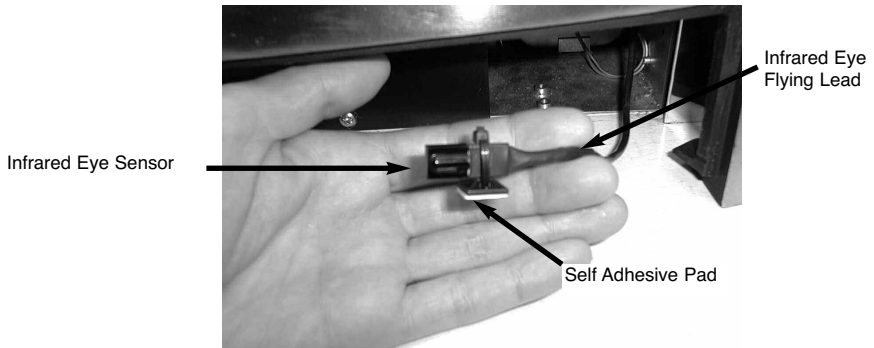

- b) Remove the backing paper from the self adhesive pad and position the infrared eye in the air channels in the ashpan cover, so that the infrared eye is flush with the front edge of the ashpan cover, as shown below in Fig. 38. Check the operation of the handset, as detailed in Section 3.3 and adjust the position of the infrared eye if necessary.

Fig. 38

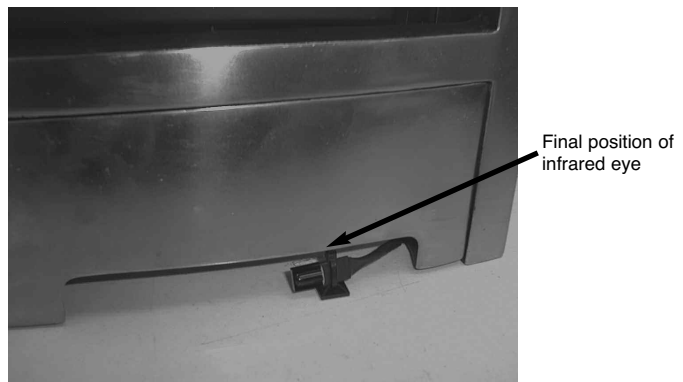

3.7 LIGHTING THE APPLIANCE (Remote Control Models)

- a) The Remote control handset generates an infrared signal, which will be received by the sensor situated at the front right of your fire, behind the black controls cover. This infrared signal requires direct line of sight from the handset to the sensor on the fire to ensure good operation.
- b) To light the appliance using the handset, point the handset at the fire and press the 2 left hand buttons together. The fire will emit a “beep” sound, the buttons can now be released. After a few seconds an audible clicking can be heard and then the fire will light the pilot and then light the main burner. The ignition cycle will take approximately 20 seconds.
- c) To reduce the level of heat input on the fire, point the handset at the fire and press the small flame button.
- d) To increase the level of heat input on the fire, point the handset at the fire and press the large flame button.
- e) To leave the fire in the standby mode (pilot only running) press the small round button on the handset.
- f) To switch the appliance off completely, press the large round button on the handset, the fire will then switch off. See Fig. 39 for image of handset.

Fig. 39

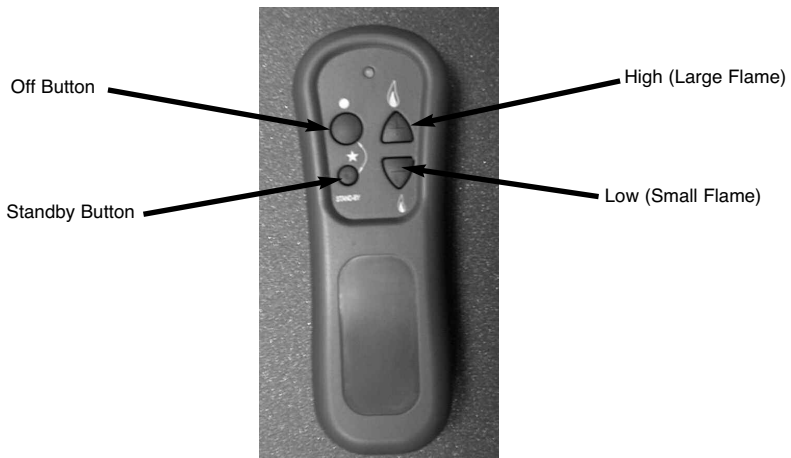

3.8 FITTING THE TRIMS & FRETS (Quasar HE Models)

- a) Fit the outer trim assembly to the firebox with the magnets provided.
- b) Remove the fret & ashpan cover from the packaging. Place fret up to the front radiused burner heat shield
- c) Place ashpan cover under fret assembly and centralise.

NOTE : Some models in this range are not supplied with a fret from the factory, therefore please consult your local retailer for fitting advice on the type of fret supplied with these models.

3.9 FITTING THE ONE PIECE FRONTIER 3 FASCIA'S

- a) Remove the protective covering from the Fascia
- b) Fit the outer trim assembly to the firebox with the magnets provided.
- c) Place ashpan cover onto fascia.

3.10 FITTING THE ONE PIECE FRONTIER 4 FASCIA'S

- a) Hook the fascia onto the top mounting bracket fitted to the firebox
- b) The bottom of the fascia is retained by magnets fitted to the lower retaining brackets.

3.8 CHECKING FOR CLEARANCE OF COMBUSTION PRODUCTS

- a) Close all doors and windows in the room.
- b) Light the fire and allow to run for approximately 5 minutes on high position.
- c) After approximately 5 minutes hold a smoke match just inside and below the centre of the lower front edge of the top of the fire as shown at the bottom of the page in Fig. 38 (It is recommended that a suitable smoke match holder is used when checking for clearance of combustion products). All smoke generated should be drawn back into the flue. If slight spillage occurs or if in doubt, repeat the test after a further 5-10 minutes. **If the test indicates that spillage is occurring and the flue restrictor baffle has been fitted, it should be removed and the test repeated after the fire has cooled.**
- d) If spillage persists, the flue is not functioning correctly and a fault exists. If, after investigation the fault cannot be traced and rectified, the fire must be disconnected from the gas supply and expert advice obtained.
- e) If there is an extractor fan fitted any where in the vicinity of the appliance, the spillage test should be repeated with the fan running on maximum and all interconnecting doors open.
- f) After ensuring that the fire is safe to use it should be left on high position to fully warm up. During this time a slight odour may be noticed, this is due to the “newness” of the fire and will soon disappear.

Finally, hand the Installation and Maintenance Instructions and the Users Instructions over to the customer and explain the operation of the fire.

Fig. 38



Smoke Match Position -
Approximately 10mm
inside the centre of the
draught diverter.

SECTION 4 MAINTENANCE

Servicing Notes

Servicing should be carried out annually by a competent person such as a registered engineer. **This is a condition of the Verine Fires guarantee schemes.**

The service should include **changing the oxypilot as a condition of the guarantee** and visually checking the chimney and fire opening for accumulations of debris and a smoke test to check for a positive up-draught in the chimney.

The condition of the coals / pebbles should be checked and **if necessary the whole set should be replaced with a genuine replacement set.**

The burner assembly is designed to be removed as a complete unit for ease of access. **After any servicing work a gas tightness check must always be carried out.**

Manual Control Fires – For Diagrams refer to Section 2

4.1 Removing the burner assembly from the fire. (MC models)

4.1.1 Prepare work area (lay down dust sheets etc.)

4.1.2 Remove the trim. Lift the fender and ash pan cover out of the way and put them in a safe location. Remove the glass panel, unscrewing the top and side retaining brackets, see page 11 & 12 of this manual for information. Carefully lift clear the glass panel. Remove the coals or pebbles, front ceramic from the rail and fuel-bed base matrix. Unscrew the two pozi-drive fixing screws which secure the burner heat shield and remove it from the fire.

4.1.3 Isolate the gas supply and remove the inlet pipe from the appliance inlet elbow. Unscrew and remove the four screws which retain the burner. Remove the burner assembly from the fire.

4.1.4 To refit the burner assembly. Push the base of the control panel fully into the fire and secure with the four screws. Refit the gas supply pipe and carry out a gas tightness test. Refit the burner heat shield then refit the coals / pebbles referring to section 3 for the correct coal / pebble layout. Refit the glass panel and glass panel retaining trims. The fender and ash pan cover or fascia can now be re-positioned.

4.2 Removing the Piezo Igniter (MC models)

4.2.1 Remove the burner assembly as in section 4.1

4.2.2 Disconnect the ignition lead from the piezo and unscrew the retaining nut on the rear of the control panel. Withdraw the piezo from the front of the control panel. Reassemble in reverse order and carry out a gas tightness test. Refit the burner heat shield then refit the coals / pebbles referring to section 3 for the correct coal layout. Refit the glass panel and glass panel retaining trims. The fender and ash pan cover or fascia can now be re-positioned.

4.3 Removing the Control Tap from the fire (MC models)

4.3.1 Remove the burner assembly as in section 4.1.

4.3.2 Pull the control knob off the control tap spindle.

4.3.3 Loosen and remove the three gas pipe retaining nuts from the control tap and release the ends of the gas pipes from the control tap body. Loosen and remove the thermocouple securing nut from the end of the control tap.

4.3.4 Unscrew the control tap locknut from the front of the control panel and remove the control tap.

4.3.5 To refit a control tap, reassemble in reverse order noting that the control tap locates with a flat in the control panel. Carry out a gas tightness test after re-assembly. Refit the burner heat shield then refit the coals / pebbles referring to section 3 for the correct coal layout. Refit the glass panel and glass panel retaining trims. The fender and ash pan cover or fascia can now be re-positioned.

4.4 Removing the Oxy-Pilot Assembly (MC models)

Note : Because this appliance is fitted with an atmosphere sensing 'Oxy-Pilot' it is not possible to replace the thermocouple separately, because the thermocouple position is factory set to a tight tolerance. Any replacement of parts on the pilot requires a complete new pilot assembly.

4.4.1 Remove the burner assembly as in section 4.1

4.4.2 Unscrew and remove the thermocouple retaining nut from the end of the control tap and disconnect the ignition lead from the pilot electrode.

4.4.3 Unscrew and remove the two pozi-driv screws which secure the pilot assembly to the burner. Remove the pilot.

- 4.4.4 Re-assemble in reverse order and carry out a gas tightness test. Refit the burner heat shield then refit the coals / pebbles referring to section 3 for the correct coal layout. Refit the glass panel and glass panel retaining trims. The fender and ash pan cover or fascia can now be re-positioned.

Slide Control Fires - For Diagrams refer to section 2

4.5 Removal of the burner assembly (SC models)

- 4.5.1 Prepare the work area (lay down dust sheets etc.)
- 4.5.2 Remove the trim. Lift the fender and ash pan cover out of the way and put them in a safe location. Remove the glass panel, unscrewing the top and side retaining brackets, see page 10 & 11 of this manual for information. Carefully lift clear the glass panel. Remove the coals / pebbles, front ceramic from the rail and fuel-bed base matrix. Remove all of the loose coals / pebbles and front ceramic rail. Unscrew the two pozi-drive fixing screws which secure the burner heat shield and remove it from the fire.
- 4.5.3 Isolate the gas supply and remove the inlet pipe from the appliance inlet elbow. To allow burner removal, the control lever operating cable must be removed. The control lever operating cable can be seen running across the base of the fire, below the burner. To release the cable, unscrew the cable securing screw located in the centre of the aluminium operating arm and pull the cable out from its fixing hole. Release the other end of the cable by pushing the cable towards the right i.e. into the operating arm so as to release the tension. Pull the cable nipple out of the retaining hole and remove the cable through the slot in the operating arm. Remove the two retaining screws at the base of the burner unit, and the screw each side of the burner unit. The base of the burner unit can now be pulled forward, allowing the burner to be removed outwards and downwards from the fire box. Remove the burner assembly from the fire.
- 4.5.4 Refit the burner assembly to the firebox by carefully pushing the bottom of the burner back into position. Secure using the two screws into the side frame of the firebox, and two screws into the base. It is now necessary to refit and correctly tension the operating cable. To do this, first set the control lever to the horizontal (central position), this is the position which creates maximum tension in the operating cable. Refit the operating cable to the aluminium operating arm, firstly locating the nipple on one end of the cable into recess in operating arm and then feed the other end through hole in operating arm. Pull the operating cable until it is finger tight and secure with screw into operating arm (do not over-tighten). Move the control lever fully downwards and check

that the left hand micro-switch operates the igniter and that the control valve spindle is fully depressed. Move the control lever upwards to the "off" position and check that the right hand (cut-off) micro-switch operates. Check that the control lever operates smoothly and safely. Refit the burner heat shield then refit the coals / pebbles referring to section 3 for the correct coal / pebble layout. Refit the glass panel and glass panel retaining trims. The fender and ash pan cover or fascia can now be re-positioned.

4.6 Removal of the battery ignitor (SC models)

4.6.1 Remove the burner assembly as described in section 4.5

4.6.2 Disconnect the ignition lead and 2 off microswitch leads from the igniter. Unscrew the Battery retaining cap and place battery to one side. Then unscrew igniter retaining ring and remove igniter from panel. Re-assemble in reverse order and carry out a gas tightness test. Refit the burner heat shield then refit the coals / pebbles referring to section 3 for the correct coal / pebble layout. Refit the glass panel and glass panel retaining trims. The fender and ash pan cover or fascia can now be re-positioned.

4.7 Replacing the battery (SC models)

4.7.1 Unscrew Battery retaining cap situated at the front right of the fire and remove the battery

4.7.2 Replace in the reverse order using a 1.5V AA Alkaline Battery.

4.8 Removing the Oxy-Pilot Assembly (SC models)

Note: Because this appliance is fitted with an atmosphere sensing 'Oxy-Pilot' it is not possible to replace the thermocouple separately, because the thermocouple position is factory set to a tight tolerance. Any replacement of parts on the pilot requires a complete new pilot assembly.

4.8.1 Remove the burner assembly as in section 4.5

4.8.2 Unscrew and remove the thermocouple retaining nut from the end of the control tap, disconnect the ignition lead from the pilot electrode and the two inline leads from the microswitch.

4.8.3 Unscrew and remove the two pozi-drive screws which secure the pilot assembly to the burner. Remove the pilot.

4.8.4 Re-assemble in reverse order and carry out a gas tightness test. Refit the burner heat shield then refit the coals / pebbles referring to section 3

correct layout.

- 4.8.4 Refit the glass panel and glass panel retaining trims. The fender and ash pan cover or fascia can now be re-positioned.
(Cont.)

4.9 Replacing the Control Cable (SC models)

- 4.9.1 The control lever operating cable can be seen running across the base of the fire, below the burner. To release the cable, unscrew the cable securing screw located in the centre of the aluminium operating arm and pull the cable out from its fixing hole. Release the other end of the cable by pushing the cable towards the right i.e. into the operating arm so as to release the tension. Pull the cable nipple out of the retaining hole and remove the cable through the slot in the operating arm. See fig. 39 opposite

Fig. 39

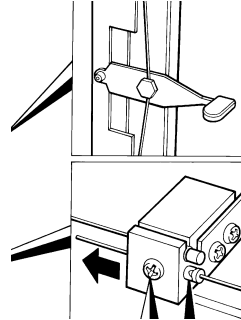

- 4.9.2 Hold the hexagonal control lever cable locking bush with a spanner and unscrew the locking screw using a 2mm allen key to release the cable from the control lever. The control cable can now be removed from the cable guide tubes.
- 4.9.3 To fit the replacement cable, thread the end of the new cable into the long length of p.t.f.e. sleeve (as supplied), taking care not to kink the sleeve. Now carefully feed the sleeve and cable into the left hand cable guide tube until the ends emerge above the control lever. Now thread the short length of p.t.f.e. sleeve over the end of the cable and thread the sleeve and cable into the top of the short cable guide tube.
- 4.9.4 When the end of the cable emerges from the short cable guide tube, locate the nipple on the other end of the cable into the locating hole in the aluminium operating arm. Thread the free end of the cable into the cable retaining hole on the operating arm, but at this stage do not tighten the securing screw.
- 4.9.5 Fit the hexagonal control lever cable locking bush onto the control lever and fit the control cable loosely into the bush in the gap between the two lengths of p.t.f.e. sleeve. Ensure that the cable is located in the retaining hole in the locking bush and tighten the screw sufficiently to retain the cable but still allowing it to slide for adjustment.

- 4.9.6 It is now necessary to correctly tension the operating cable. To do this, first set the control lever to the horizontal (central position), this is the position which creates maximum tension in the operating cable. Pull the free end of the operating cable through the operating arm until it is finger tight and secure with screw into operating arm (do not over tighten).
- 4.9.7 Slide the operating arm fully to the right hand position and hold in position, slide the control lever relative to the cable until the cable retaining screw lines up with the hole in the spacer frame. This sets the control lever in the correct position. Hold the hexagonal locking bush with a spanner and tighten the retaining screw using the 2mm allen key. Move the control lever fully downwards and check that the left hand micro-switch operates the igniter and that the control valve spindle is fully depressed. Move the control lever upwards to the "off" position and check that the right hand (cut-off) micro-switch operates. Check that the control lever operates smoothly and safely.

Remote Control Fires - For Diagrams refer to section 2

5.1 Removing the RC Burner Assembly (RC models)

- 5.1.1 Prepare work area (lay down dust sheets etc.)
- 5.1.2 Remove the trim. Lift the fender and ash pan cover out of the way and put them in a safe location. Isolate the gas supply. Remove the glass panel, unscrewing the top and side retaining brackets, see page 11 & 12 of this manual for information. Carefully lift clear the glass panel. Remove the coals / pebbles, front ceramic from the rail and fuel-bed base matrix. Remove all of the loose coals / pebbles and front ceramic rail. Unscrew the two pozi-drive fixing screws which secure the burner heat shield and remove it from the fire.
- 5.1.4 Unscrew the 2 off burner retaining screws on the side brackets, the burner should then be lifted out of the firebox.
NOTE : Please take care with the wiring loom
- 5.1.5 To refit the burner assembly, re-assemble in reverse order and carry out a gas tightness test. Refit the burner heat shield then refit the coals / pebbles referring to section 3 for the correct coal / pebble layout. Refit the glass panel and glass panel retaining trims. The fender and ash pan cover or fascia can now be re-positioned.

5.2 Removing the Remote Gas Valve from the fire (RC models)

- 5.2.1 Prepare work area (lay down dust sheets etc.)

- 5.2.2 Remove the burner assembly as described in section 5.1.
- 5.2.3 Disconnect pilot, main and injector pipes and disconnect the wiring loom thermocouple and ignition wire, the valve can then be removed.
Re-assemble in reverse order, refit the burner heat shield then refit the coals / pebbles referring to section 3 for the correct coal / pebble layout. Refit the glass panel and glass panel retaining trims. The fender and ash pan cover or fascia can now be re-positioned.

5.3 Removing the Pilot Assembly (RC models)

Note : Because this appliance is fitted with an atmosphere sensing ‘Oxy-Pilot’ it is not possible to replace the thermocouple separately, because the thermocouple position is factory set to a tight tolerance. Any replacement of parts on the pilot requires a complete new pilot assembly.

- 5.3.1 Prepare work area (lay down dust sheets etc.)
- 5.3.2 Remove the burner assembly as described in section 5.1.
- 5.3.3 Loosen the pilot nut and remove the two screws retaining the pilot assembly. Unscrew the thermocouple from the gas valve.
- 5.3.4 Re-assemble in reverse order, refit the burner heat shield then refit the coals / pebbles referring to section 3 for the correct coal / pebble layout. Refit the glass panel and glass panel retaining trims. The fender and ash pan cover or fascia can now be re-positioned.

5.4 Replacing the Batteries (Within the Radio Frequency Receiver)

- 5.4.1 Prepare work area (lay down dust sheets etc.)
 - 5.4.2 Remove the trim / fret & ashpan cover.
 - 5.4.3 The RF receiver is located on the right hand side of the product, below the burner assembly. Slide the RF receiver out, slide the battery cover off and replace the batteries as necessary.
 - 5.4.4 The fender and ash pan cover or fascia can now be re-positioned.
- NB The handset uses one LR61 (9v) and should be replaced by removing the cover on the rear of the handset.

**ENSURE THE BATTERIES ARE CONNECTED TO THE CORRECT POLARITY
POSITIVE (+), NEGATIVE (-)**

FRET INFORMATION

To enable Customers to choose their own style of fret these fires are now available without frets. In order to maintain the efficient and safe operation of the fire it is important that any fret which is used must comply with the following dimensions. (Fig. 39) It is important to clean a fret in accordance with the instructions provided by your retailer as these vary depending on the surface finish of the fret.

Fig. 39

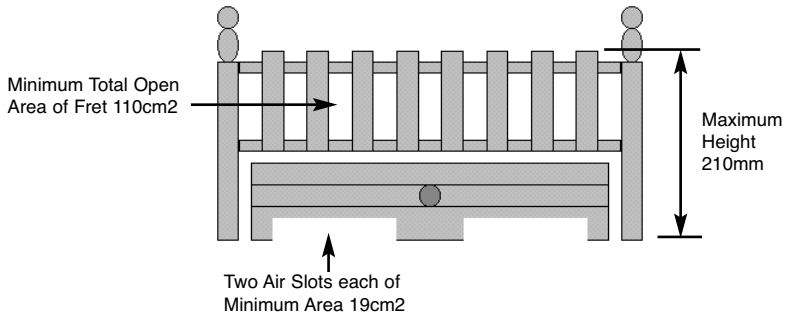

PARTS SHORTLIST

Replacement of parts must be carried out by a competent person such as a registered gas installer. The part numbers of the replaceable parts are as follows, these are available from your local stockist, whose details may be found on the BFM Europe website, address as per rear page.

Complete pebble / ceramic set	B-110000
Pebble fuelbed base	B-109980
Pebble fuelbed front rail	B-108050
Replacement pebble set	B-110020
Complete coal / ceramic set	B-121620
Coal fuelbed base	B-109980
Coal fuelbed front rail	B-126520
Replacement coal set	B-121630
Glass panel	B-125630
Piezo Igniter	B-1320
Ignition Wire Manual Models	B-67910
NG Manual Gas Valve	B-102880
LPG Manual Gas Valve	B-102960
NG Slide Valve	B-40980
NG Remote Control Valve	B-106790
Control Board	B-106800
Battery Cable	B-106810
Battery Holder	B-106820

SECTION SIX - USER INSTRUCTIONS

6.1 INSTALLATION INFORMATION

CONDITIONS OF INSTALLATION

It is the law that all gas appliances are installed only by a competent (e.g. a Registered) Installer, in accordance with the installation instructions and the Gas Safety (Installation and Use) Regulations 1998. Failure to install appliances correctly could lead to prosecution. It is in your own interest and that of safety to comply with the law.

The fire may be fitted below a combustible shelf provided that the shelf is at least 200mm above the top of the appliance and the depth of the shelf does not exceed 150mm.

The fire may be installed below combustible shelves which exceed 150mm deep providing that the clearance above the fire is increased by 15mm for each 25mm of additional overhang in excess of 150mm.

No purpose made additional ventilation is normally required for this appliance when installed in G.B. When installed I.E. please consult document I.S. 813 : 1996 Domestic Gas Installation which is issued by the National Standards Authority of Ireland. Any purpose made ventilation should be checked periodically to ensure that it is free from obstruction.

If the chimney or flue has been previously used by appliances burning fuels other than gas they must be swept prior to the installation of this fire.

If this appliance is fitted directly on to a wall without the use of a fireplace or surround, soft wall coverings such as wallpaper, blown vinyl etc. could be affected by the heat and hot convection air and may discolour or scorch. This should be considered when installing or decorating.

The Model number of this appliance is as stated on the rating plate affixed to the control panel of the fire and the appliance is manufactured by:-

BFM Europe Ltd
Trentham Lakes
Stoke on Trent
ST4 4TJ

ABOUT YOUR NEW QUASAR HE (High Efficiency) Gas Fire

The Verine High Efficiency coal / pebble effect gas fire incorporates a unique and highly developed fuel bed which gives the realism of a loose coal / pebble layout combined with realistic flames and glow. The use of durable ceramic material in the construction of the fuelbed components ensures long and trouble free operation.

When first using your new fire a slight smell may be noticed. This is due to starch used in the manufacture of the soft ceramic coals / pebbles, it is non-toxic and will soon disappear.

Please take the time to fully read these instructions as you will then be able to obtain the most effective and safe operation of your fire.

IMPORTANT SAFETY INFORMATION

WARNING

This appliance has a naked flame and as with all heating appliances a fireguard should be used for the protection of children, the elderly and infirm. Fireguards should conform to B.S. 8423 : 2002 (Fireguards for use with gas heating appliances).

It is important that this appliance is serviced at least once a year by a registered gas installer and that during the service the fire is removed from the fire opening and the chimney or flue visually checked for fallen debris or blockages which must be removed. The chimney should also be checked to ensure clearance of flue products. We recommend that during the annual service, replacement of the Oxypilot is carried out. **This is a condition of the manufacturers guarantee.**

After installation or during servicing a spillage test must always be carried out.

Rubbish of any type must NEVER be thrown onto the fuel bed, this could affect safe operation and damage the fire.

Any debris or deposits should be removed from the fuel bed from time to time. This may be carried out by referring to the cleaning section as described later in this book. Only the correct number and type of coals or pebbles must be used and only complete and genuine replacement sets must be used.

Always keep furniture and combustible materials well clear of the fire and never dry clothing or items either on or near to the fire. Never use aerosols or flammable cleaning products near to the fire when it is in use.

The ceramic fuel bed remains hot for a considerable period after use and sufficient time should be allowed for the fire to cool before cleaning etc.

The fire must only be operated with a fret or fascia as supplied with the product. which meets the criteria described in the rear of this book.

6.2.1 OPERATING THE FIRE (MANUAL CONTROL MODELS)

The controls are located behind the ashpan cover which is situated behind the Ashpan / Fender. The controls, comprise a control valve to adjust the gas flow and a push button piezo igniter. There is also a flame adjuster which slides from left to right on coal models only. The left hand position gives maximum radiant heat and output whereas the right hand position gives more flame but slightly less glow. To light the fire proceed as follows:-

- 1) Depress the control knob and turn anti-clockwise to the position marked pilot. Hold in the control knob for a few seconds to allow the gas to reach the pilot.
- 2) Continue to hold-in the control knob and press the igniter button. If the pilot does not light, continue to press the igniter button until ignition occurs. The pilot flame can be seen by looking at the left hand side front bottom corner of the glass panel. When the pilot has lit, continue to hold the control knob in for 5-10 seconds to allow the thermocouple to heat up, if the pilot goes out when the control knob is released, repeat the lighting sequence.

In the unlikely event of a failure of the igniter, the fire can be lit as follows :-
Remove the fret / ashpan cover, depress the control knob and turn anti-clockwise to the position marked pilot. Hold in the control knob for a few seconds to allow the gas to reach the pilot. Insert the tip of a lit taper in behind the front ceramic rail on the left hand side. This will light the pilot flame. When the pilot has lit, continue to hold the control knob in for 5-10 seconds to allow the thermocouple to heat up, if the pilot goes out when the control knob is released, repeat the lighting sequence.

- 3) After lighting, turn the control knob in the anti-clockwise direction to the high position and the main burner will light. For most efficient performance the fire is allowed to warm up for 10 minutes with the gas control on high.
- 4) The gas control can be turned clockwise from the maximum position to give the desired heat output.

WARNING

If the fire goes out for any reason or is turned off and it is necessary to re-light the fire it is important to allow the fire to cool for 3 minutes before attempting to re-light it.

6.2.2 OPERATING THE FIRE (SLIDE CONTROL MODELS)

The controls comprise a control lever, to turn the fire on and off and adjust the gas rate. The control lever is located at the top right hand side of the fire. Depressing the control lever fully operates the igniter and lights the pilot flame and ignition rate gas. Once the pilot is established raising the lever allows medium and finally high gas settings. The fire is turned off when the control lever is fully raised.

To light the fire proceed as follows:-

- 1) Depress the control lever fully downwards to the position marked "Z". Hold down the control lever for a few seconds to allow the gas to reach the pilot.
- 2) The fire will then begin its ignition sequence. If the pilot does not light, continue to press the control lever until ignition occurs. The pilot flame can be seen by looking underneath the front ceramic rail, above the burner heat shield, at the front left hand side of the fuel. When the pilot has lit, continue to hold the control lever down for 5-10 seconds to allow the thermocouple to heat up, before releasing the lever apply one firm downwards push to ensure that the f.s.d. valve is fully latched, if the pilot goes out when the control lever is released, repeat the lighting sequence.

In the unlikely event of a failure of the igniter, firstly check the operation of the 1.5V battery and if necessary replace with a 'AA' size alkaline battery. **It is important that only an alkaline battery is used, otherwise premature battery failure and leakage may result.** If the appliance still fails to light the fire can be lit as follows:

Remove the fret & ashpan cover. Depress the control lever fully downwards to the position marked "Z". Hold in position for a few seconds to allow the gas to reach the pilot. Insert the tip of a lit taper in behind the front ceramic rail on the left hand side. This will light the pilot flame and low rate gas. When the pilot has lit, continue to depress the control lever in for 5-10 seconds to allow the thermocouple to heat up before releasing the control lever apply one firm downwards push to ensure that the f.s.d. valve is fully latched.

- 3) After lighting, move control lever up to the high position and the main burner will light. For the most efficient performance the fire is allowed to warm up for 10 minutes on with the control lever set to high.
- 4) The gas control can be moved from the High to Low position to give the desired heat output.
- 5) To turn the fire off, FULLY raise the control lever to the OFF position.

6.2.3

OPERATING THE FIRE (REMOTE CONTROL MODELS)

- a) The Remote control handset generates an infrared signal, which will be received by the sensor situated at the front right of your fire, behind the black controls cover. This infrared signal requires direct line of sight from the handset to the sensor on the fire to ensure good operation.
- b) To light the appliance using the handset, point the handset at the fire and press the 2 left hand buttons together. The fire will emit a “beep” sound, the buttons can now be released. After a few seconds an audible clicking can be heard and then the fire will light the pilot and then light the main burner. The ignition cycle will take approximately 20 seconds.
- c) To reduce the level of heat input on the fire, point the handset at the fire and press the small flame button.
- d) To increase the level of heat input on the fire, point the handset at the fire and press the large flame button.
- e) To leave the fire in the standby mode (pilot only running) press the small round button on the handset.
- f) To switch the appliance off completely, press the large round button on the handset, the fire will then switch off. See Fig. 1 for image of handset.

Fig. 1

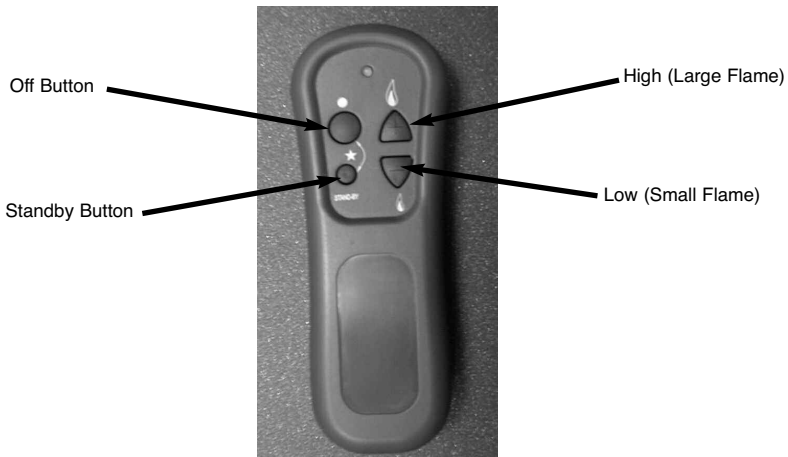

6.2.3 TURNING THE PRODUCT OFF IN THE UNLIKELY EVENT OF A REMOTE HANDSET MALFUNCTION.

- a) In the unlikely event of the remote control handset malfunctioning (or if lost or broken) after the appliance has been turned on, the fire can be turned off via the emergency shut off switch on the control panel.
- b) To turn the product off, firstly remove the ashpan from the fire.
- c) Press and hold the emergency shut off switch until the fire shuts down. The process may take up to sixty seconds to complete. (see Fig. 2 below).
- d) When the fire has shut down, release the emergency shut off switch.
- e) The appliance will now remain in the “off” position until activated by the remote handset.

Fig. 2



REPLACING THE BATTERIES (REMOTE CONTROL MODELS ONLY)

ENSURE THE FIRE IS COOL BEFORE REPLACING BATTERIES

Remove the ashpan cover. The battery pack is located on the right hand side side of the burner unit at the bottom. Carefully remove the pack and remove batteries. Replace in the reverse order using 6 off 1.5V AA Alkaline Battery. It is important that only an alkaline battery is used, otherwise premature battery failure and leakage may result.

6.3 RE-ASSEMBLING THE CERAMICS AND FUEL BED - COAL MODELS

NOTE : The position of the fuel-bed components are critical to the performance of the product. Therefore please ensure that the fuel-bed components are positioned as described in the following section prior to requesting a service call due to soot build up, poor flame pattern etc.

- a) Remove the glass panel and retaining trims as detailed on page 11 & 12. Place the ribbed ceramic fuelbed base on top of the fuelbed support and pull fully forwards to the burner. **Make sure that the fuelbed base is located centrally in the fire box. Ensure that the fuelbed base fit fully down onto the fuel bed support and is not lodged on the burner. Ensure the air ports as indicated by the arrows are not blocked by the fuel-bed matrix.** See fig. 3 & 4 below.

Fig. 3

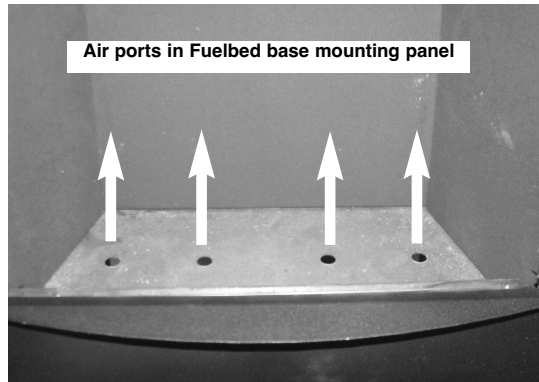
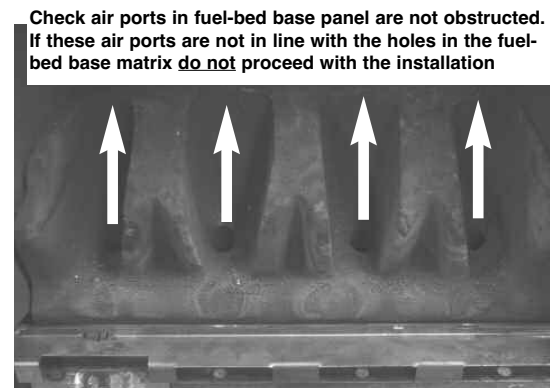
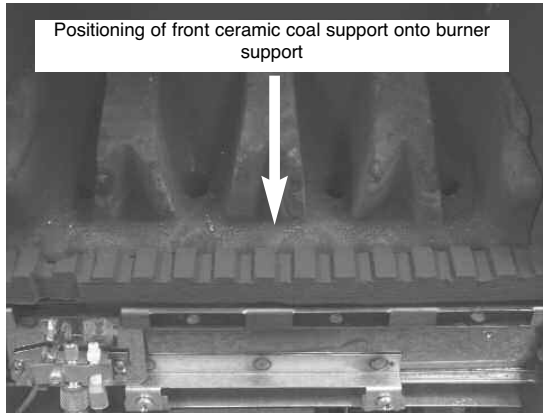

Fig. 4



- b) Position the front ceramic coal support onto the burner support as shown below in Fig. 5

Fig. 5



- c) Fit three large coals and one rectangular coal between the front rail and the fuel-bed matrix as shown below in Fig. 6

Fig. 6



- d) Fit two small coals at the end of the row as shown below in Fig. 7.

Fig. 7



- e) Fit three large coals behind the front row, using the ribs in the fuel-bed base as a guide for placement as shown below in Fig. 8.

Fig. 8

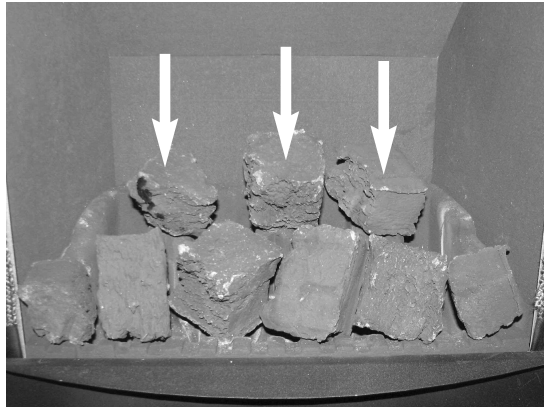

- f) Fit two small coals at the end of the row as shown below in Fig. 9.

Fig. 9



- g) Fit the rear row of 3 coals as shown below in Fig. 10

Fig. 10

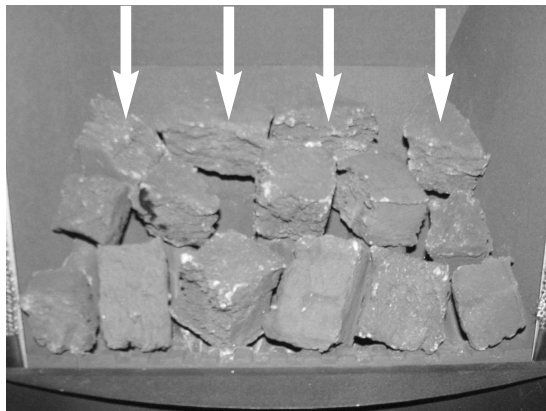

The exact position and fit of the coals may be very finely adjusted to give the most pleasing and random appearance.

Warning : Use only the coals supplied with the fire. When replacing the coals remove the old coals and discard them. Fit a complete set of coals of the correct type. Do not fit additional coals or any coals other than a genuine replacement set.

To ensure that the release of fibres from these R.C.F (Refractory Ceramic Fibre) articles is kept to a minimum, during installation and servicing we recommend that you use a HEPA filtered vacuum to remove any dust accumulated in and around the appliance before and after working on the appliance. When replacing these articles we recommend that the replaced items are not broken up, but are sealed within heavy duty polythene bags, clearly labelled as “RCF waste”. RCF waste is classed as a “stable”, non reactive hazardous waste and may be disposed of at a landfill licensed to accept such waste Protective clothing is not required when handling these articles, but we recommend you follow the normal hygiene rules of not smoking, eating or drinking in the work area, and always wash your hands before eating or drinking.

h.) Replace the glass panel and retaining trims as described on pages 11 & 12

NEVER USE THE FIRE WITHOUT THE GLASS PANEL IN POSITION, OR IF BROKEN OR CRACKED.

6.4 RE-ASSEMBLING THE CERAMICS AND FUEL BED - PEBBLE MODELS

- a) Remove the glass panel and retaining trims as detailed on page 11 & 12. Place the ribbed ceramic fuelbed base on top of the fuelbed support and pull fully forwards to the burner. **Make sure that the fuelbed base is located centrally in the fire box. Ensure that the fuelbed base fit fully down onto the fuel bed support and is not lodged on the burner. Ensure the air ports as indicated by the arrows are not blocked by the fuel-bed matrix.** See fig. 11 & 12 below.

Fig. 11

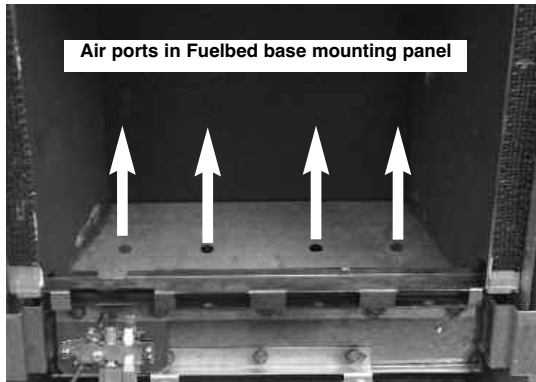
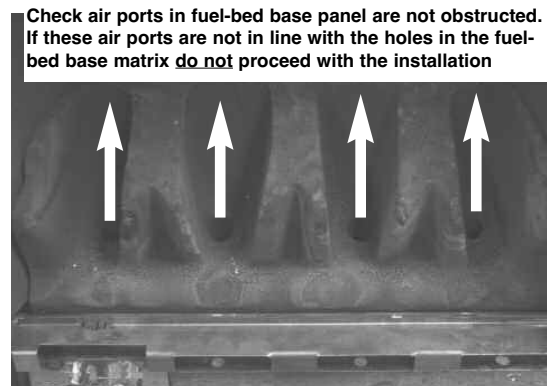
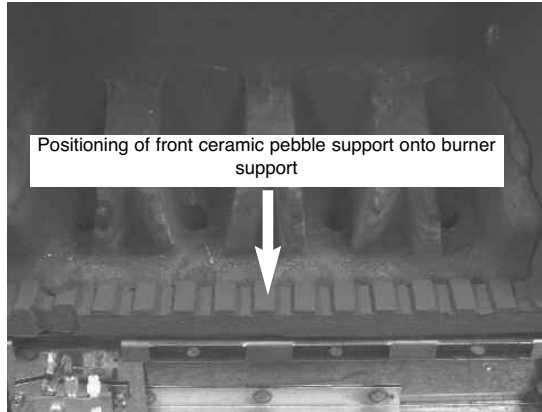

Fig. 12



- b) Position the front ceramic pebble support onto the burner support as shown below in Fig. 13

Fig. 13



- c) Fit four of the specially shaped pebbles as shown below in fig 14. Ensure that the cut-out in the rear face of the pebbles is positioned as indicated. The 4 off specially shaped pebbles are packed in a bag with a label "FR" on them.

Fig. 14

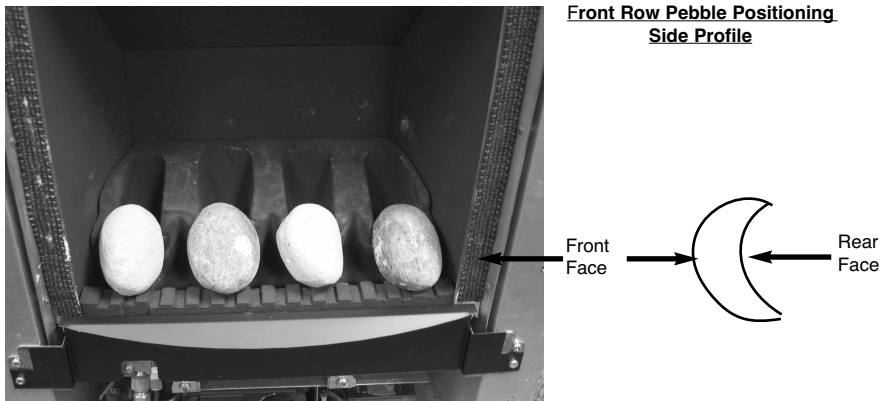

- d) Select three of the large pebbles and position on the three central ribs in the fuelbed as indicated in Fig. 15 below.

Fig. 15

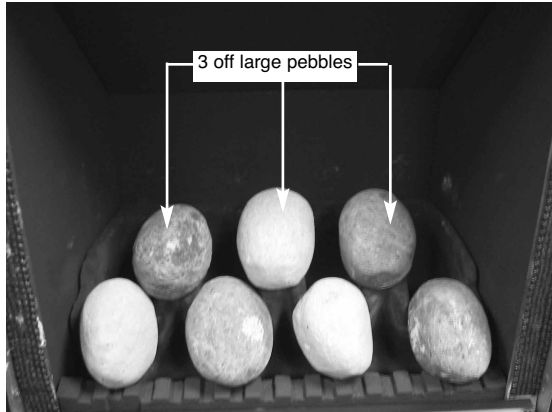

- e) Select the two small pebbles and arrange along the second row of the fuelbed. (See fig. 16 below)

Fig. 16

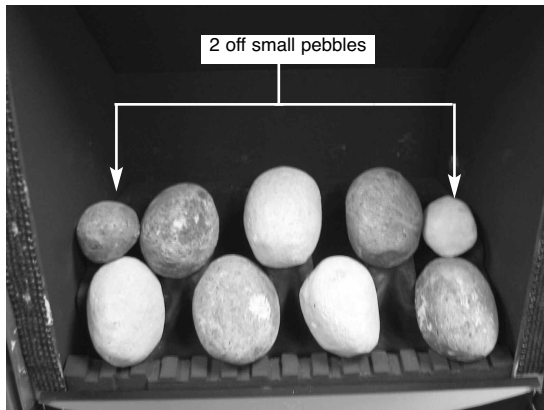

- f) Select the four remaining large pebbles and position as shown along the rear of the fuel-bed base in fig. 17 below.

Fig. 17

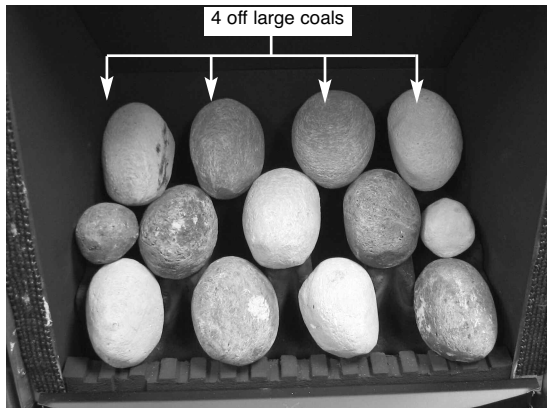

- g) Do a final check that the pebbles are layed out as shown below in Fig. 18

Fig. 18

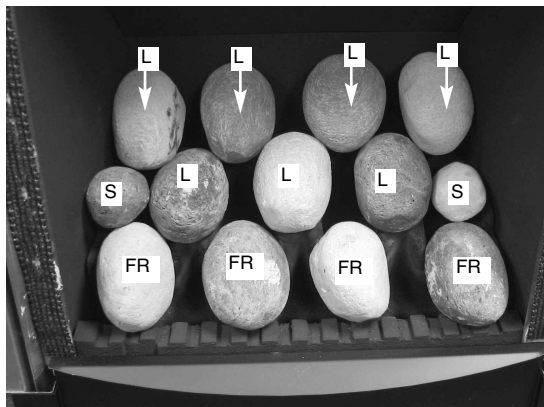

The exact position and fit of the pebbles may be very finely adjusted to give the most pleasing and random appearance.

Warning : Use only the pebbles supplied with the fire. When replacing the pebbles remove the old pebbles and discard them. Fit a complete set of pebbles of the correct type. Do not fit additional pebbles or any pebbles other than a genuine replacement set.

To ensure that the release of fibres from these R.C.F (Refractory Ceramic Fibre) articles is kept to a minimum, during installation and servicing we recommend that you use a HEPA filtered vacuum to remove any dust accumulated in and around the appliance before and after working on the appliance. When replacing these articles we recommend that the replaced items are not broken up, but are sealed within heavy duty polythene bags, clearly labelled as “RCF waste”. RCF waste is classed as a “stable”, non reactive hazardous waste and may be disposed of at a landfill licensed to accept such waste Protective clothing is not required when handling these articles, but we recommend you follow the normal hygiene rules of not smoking, eating or drinking in the work area, and always wash your hands before eating or drinking.

h.) Replace the glass panel and retaining trims as described on pages 10 & 11

NEVER USE THE FIRE WITHOUT THE GLASS PANEL IN POSITION, OR IF BROKEN OR CRACKED.

6.5 CLEANING THE FIRE - WARNING

Before attempting any cleaning operation ensure that the fire has been allowed to fully cool. Consult your retailer to determine what trim / fret / fascia option was supplied with your fire. If a real Brass fret was supplied with the fire it will therefore will discolour with use and should be cleaned with a proprietary metal polish. A laquered brass fret should not discolour and should only be cleaned with a clean, damp cloth. The chrome, black & brass effect trims and chrome effect fret that are supplied with the fire (dependent upon model chosen) should only also be cleaned with a clean, damp cloth.

The trim is best cleaned in position on the fire when the appliance is not running and is cool. Black painted metal parts should be gently cleaned with a damp cloth.

6.6 CLEANING THE FUEL-BED

We do not recommend cleaning of the coals / pebbles or fuelbed components as these are fragile and damage may result. **None of these parts must be washed or exposed to any cleaning agents or water.** Any damaged parts must be replaced by contacting your dealer or telephoning BFM Europe Ltd. on the number stated on the rear cover of this book. The coals / pebbles must only be replaced with a complete and genuine replacement set and the fire must never be run with the wrong number or damaged coals / pebbles. The fuel-bed must be carefully re-assembled as stated in section 6.3 / 6.4

To clean the glass panel, please remove it from the product as described in pages 10-11. Use a clean damp cloth and ceramic glass cleaner to remove any stains or deposits from the glass panel. Do not use scouring pads as this may scratch the surface finish of the glass panel.

PLEASE NOTE :- The glass will require cleaning periodically. Condensation produced by the products of combustion will create marks on the inside face of the glass panel.

6.7 REMOVAL AND RE-FITTING THE TRIMS / FRETS / FASCIA'S

Please refer to pages 35 of the Installation section of this manual.

6.8 USER REPLACEABLE PARTS

The only user replaceable parts on this fire are the fuelbed components and coals / pebbles which may be replaced as described in section 6.3 / 6.4. In order to replace the fuel-bed components, the glass panel of the appliance will need to be removed, please refer to pages 11 & 12 of this book for details on how to remove the glass panel.

Replacement of any other parts must be carried out by a competent person such as a registered gas installer. The part numbers of the user replaceable parts are as follows, these are available from BFM Europe Ltd. who may be contacted at the number on the rear cover of this book.

Complete pebble / ceramic set	B-110000
Pebble fuelbed base	B-109980
Pebble fuelbed front rail	B-126520
Replacement pebble set	B-110020
Complete coal / ceramic set	B-121620
Coal fuelbed base	B-109980
Coal fuelbed front rail	B-108050
Replacement coal set	B-121630

Due to our policy of continual improvement and development the exact accuracy of illustrations and descriptions contained in this book cannot be guaranteed

**Part No. B-124980
Issue 7**

V E R I N E
FIRES ✦ TO ✦ INSPIRE

BFM Europe Ltd.
Trentham Lakes
Stoke-on-Trent
Staffordshire
ST4 4TJ

www.bfm-europe.com

Telephone - General Enquiries : (01782) 339000
Telephone - Service : (0844) 7700169