



1 VALENTINES BUILDINGS

Bechers drive

Aintree racecourse Business Park

L9 5ay

CF1L BOSTON & CF1L WIDE BOSTON

GAS APPLIANCE

INSET CONVENTIONAL FLUED GAS FIRE

INSTALLATION & USERS INSTRUCTIONS

FOR USE WITH NATURAL GAS

CATEGORY I_{2H}

G20 @ 20 mbar

For use in GB and IE

CE



THESE INSTRUCTIONS MUST BE LEFT WITH THE USER FOR FUTURE REFERENCE

THE CF1L BOSTON & CF1L WIDE BOSTON

CONTENTS

SECTION	INFORMATION & REQUIREMENTS	PAGE
1.0	IMPORTANT NOTES	3
2.0	INSTALLATION REQUIREMENTS	4
3.0	APPLIANCE INFORMATION	6
4.0	FLUES AND BUILDERS OPENING REQUIREMENTS	7
5.0	FIREPLACE OPENING SIZES AND CATCHMENT SPACE	8
6.0	INSTALLING THE CONVECTOR BOX	9
7.0	CONNECTING THE GAS AND TESTING	10
8.0	INSTALLING THE FUEL PIECES	10
9.0	LIGHTING THE APPLIANCE (USERS INSTRUCTIONS)	18
	LIGHTING THE APPLIANCE MANUAL VERSION	26
10.0	INSTRUCT THE USER	27
11.0	MAINTENANCE	27
12.0	SERVICING	28

1:1

This fire should be installed and serviced every 12 months in accordance with current gas safety (Installation and uses) regulations by a competent person who is a member of a recognised gas installer's Organisation (e.g. Gas safe) and in accordance with the installation instructions.

1:2

The flue should be inspected before your appliance is installed and checked annually to ensure continuous Clearance of combustion products and safe operation.

The chimney must be swept before installation.

1:3

UNDER NO CIRCUMSTANCES must the fire be used if the glass door panel is broken cracked or Damaged

1:4

IMPORTANT.

The glass panel door and other outer parts, (e.g. outer frame and door) will become hot in use; clothes Etc. should not be wrapped over or near the fire and we recommend that a 'fire guard conforming to BS 8423 should be used for the protection of young children the elderly the infirm and pets'.

1:5

DO NOT burn paper or rubbish in the fire.

1:6

It is important for the safe operation and to maintain efficiency that the fire is not operated with damaged or Broken fuel effect pieces or ceramics.

UNDER NO CIRCUMSTANCES should extra fuel effect pieces be used.

1:7

When the fire is first used it may emit a slight odour or smoke, this is due to the newness and will Disappear. DO NOT WASH OR VACUUM the Fuel Effect ceramic pieces.

1:8

The fire MUST be installed into a Builders Opening in line with the Installation Instructions.

No combustible material should be placed within 150mm of the appliance

Any combustible material above the opening should be removed up to a height of

300 mm. any shelf above the fire should not project more than 150mm forward.

For deeper shelves allow a 15mm increase in height for every 25mm in depth.

1:9

These instructions are intended to assist you in the correct operation of your appliance and Should be kept safe for future reference

The Benchmark Scheme

Benchmark places responsibilities on both manufacturers and installers. The purpose is to ensure that customers are provided with the correct equipment for their needs, that it is installed, commissioned and serviced in accordance with the manufacturer's instructions by competent persons and that it meets the requirements of the appropriate Building Regulations. The Benchmark Checklist can be used to demonstrate compliance with Building Regulations and should be provided to the customer for future reference.

Installers are required to carry out installation, commissioning and servicing work in accordance with the Benchmark Code of Practice which is available from the Heating and Hotwater Industry Council who manage and promote the Scheme. Visit www.centralheating.co.uk for more information.

2: INSTALLATION REQUIREMENTS

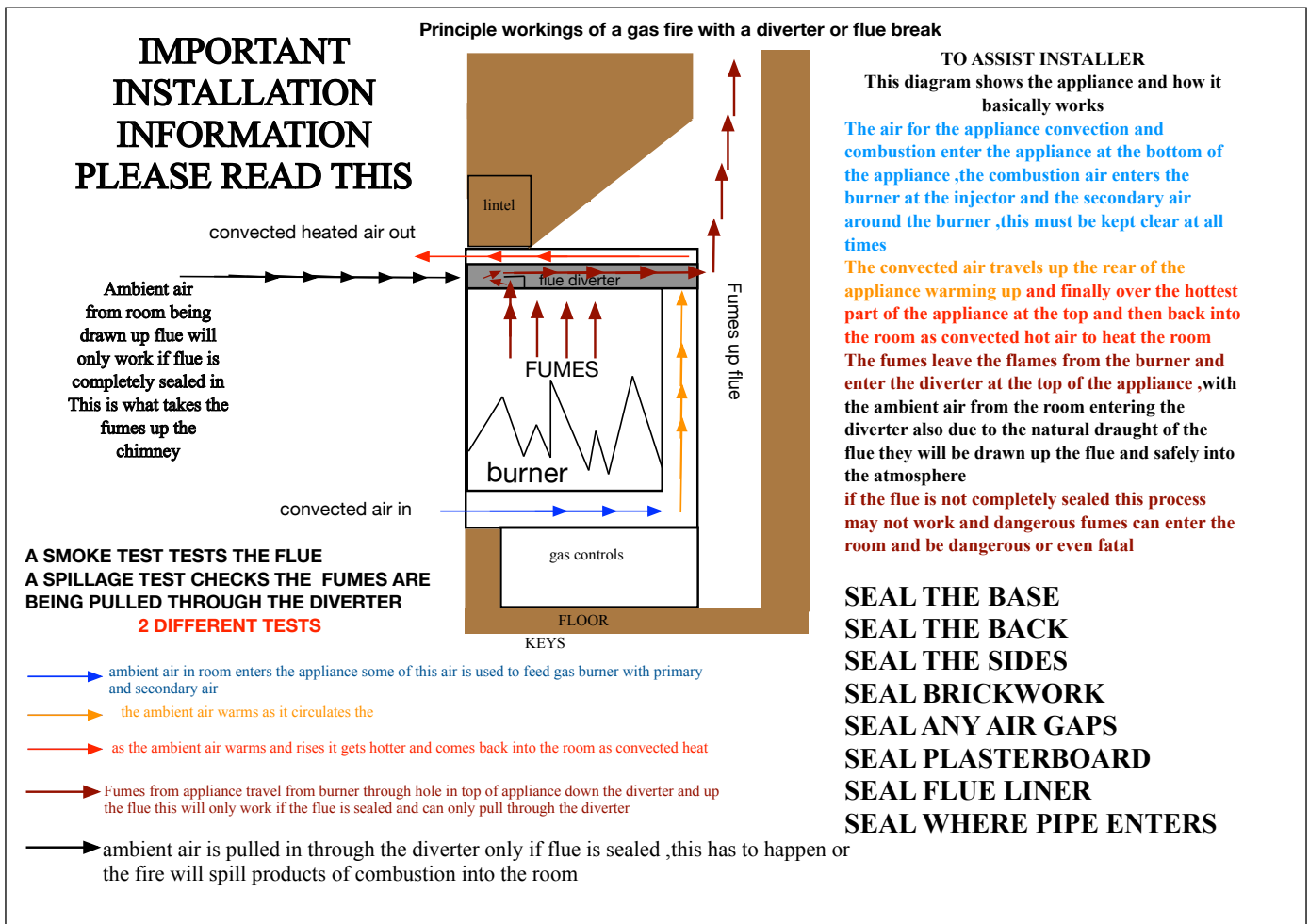

THE ABOVE DIAGRAM SHOWS THE WAY THE CF1L BOSTON & CF1L WIDE BOSTON WORKS ,FOLLOW THIS CAREFULLY THE FIRE MUST BE SEALED IN AIRTIGHT FOR THE SAFE OPERATION AND USE OF THIS APPLIANCE THE ONLY PLACE THE FLUE SHOULD PULL IS THROUGH THE DIVERTER

2:1

In your own interest and that of safety, it is law, that a competent person who is a member of a recognised gas installation organisation must install all gas appliances (**E.g.** Gas safe) In accordance with Current Gas Safety (**INSTALLATION AND USE**) Regulations.

2:2

Before installation, ensure that the local distribution conditions (identification of the gas and pressure) and the adjustment of the appliance are compatible.

The installation must be in accordance with these installation instructions and all relevant parts of the Local and National Building Regulations, the Building Standards (Scotland) Regulations and the relevant recommendations of current editions of the following British Standards: -

BS	BS	BS	BS	BS
5871	8303	5440 PART 1	5440 PART 2	6891

2:3

IMPORTANT: This appliance is fitted with a spillage monitoring system, (ODS) and must not be adjusted, bypassed or Put out of operation, by the user or installer. Any parts of this system should only be exchanged for genuine crystal Manufacture parts.

This fire must not be installed in a room that contains a bath or shower.

This fire cannot be installed onto a combustible wall. All combustible materials must be removed from the area shown in section 11-appliance location

2:4

No combustible materials must be present in the builders opening.
These Instructions must be left with the User.

2:5

VENTILATION: GB

For installation in Great Britain additional ventilation is not normally required unless indicated as being required by the 'Spillage Test'

2:6

VENTILATION: IE

For installation in Southern Ireland ventilation must be in accordance with I.S813 Domestic Gas Installations.

2:7

FLUE AND CHIMNEY SUITABILITY

This appliance is designed for use with conventional brick built or lined chimneys and fabricated flues and metal flue boxes conforming to BS715 / BS EN 1856-2 .all flues must conform to the following minimum dimensions

2:8

Minimum diameter circular flues 125 mm

Minimum effective height of all class 1 (175mm) flues 3 metres

Minimum effective height of all class 2 (125mm) flues 4 metres

2:9

ENSURE THAT IF INSTALLING THIS PRODUCT INTO A BRICK BUILT CHIMNEY, THE CHIMNEY HAS BEEN FULLY SWEEPED PRIOR TO PROCEEDING WITH THE INSTALLATION

3: APPLIANCE INFORMATION

CF1L BOSTON & CF1L WIDE BOSTON				
	WIDE MANUAL	WIDE REMOTE	STANDARD MANUAL	STANDARD REMOTE
GAS G20	NG	NG	NG	NG
INJECTOR SIZE	420	500	380	500
HEAT INPUT HIGH	6.3kW	6.3kW	5.7kW	5.7kW
HEAT INPUT LOW	4.0kW	4.0kW	2.7kW	2.7kW
PRESSURE	20 +/- 1mbar	20 +/- 1mbar	20 +/- 1mbar	20 +/- 1mbar
IGNITION SEQUENCE	Manual	Automatic	Manual	Automatic
SPARK GAP	4mm	4mm	4mm	4mm
WEIGHT FULLY PACKED	Kg	Kg	Kg	Kg
GAS SUPPLY PIPE SIZE	8mm	8mm	8mm	8mm

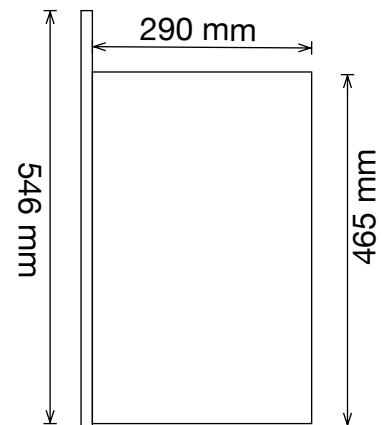
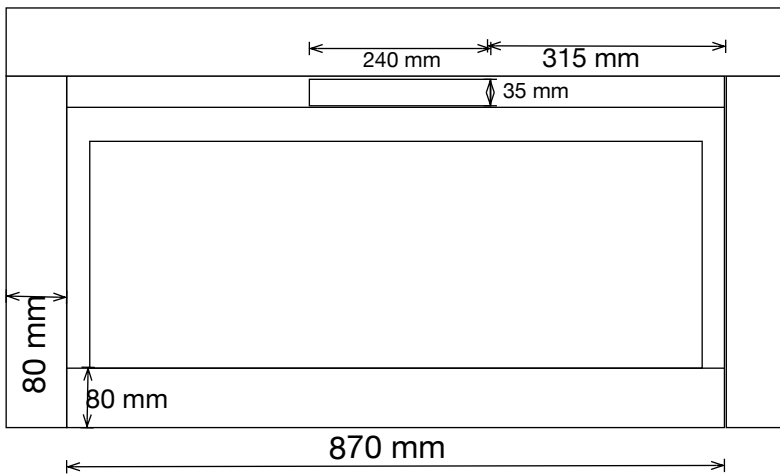

ABOVE CF1L BOSTON WIDE BOX SIZES ,BELOW CF1L BOSTON STANDARD BOX SIZES
NOT SHOWING TRIMS

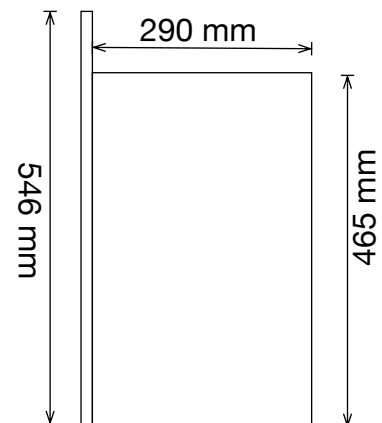
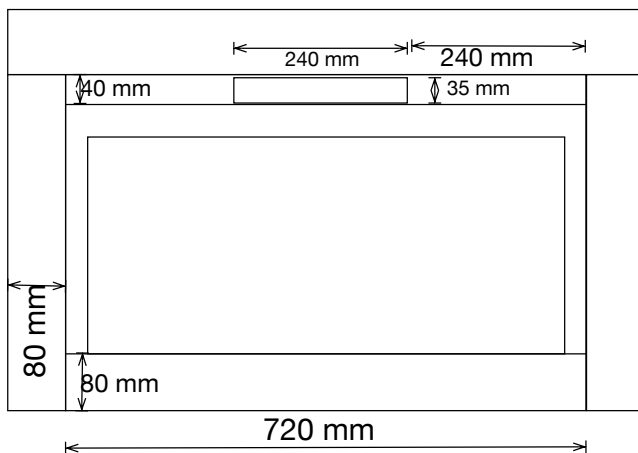

4.1

Prior to creating the builders opening the flue must be checked.

No restrictor plate or flue damper is permitted.

The flue must be swept prior to installation.

The flue must be free of any obstructions.

The flue must be checked to ensure it **only** serves the fireplace opening to be used for the fire.

The flue must have a positive up-draught and checked as follows before the builders-opening is constructed

Any under floor air supply to the fireplace must be completely sealed off

Before installing the fire a simple smoke test should be carried out on the flue to check its condition. Light a smoke

Generator, hold it at the top of the fireplace opening and observe that the smoke is being drawn up the flue, if so,

proceed with installation. If not, pre heat the Flues for a few minutes and recheck, if smoke still fails to be drawn up the flue, further Investigation is required and the appliance **MUST NOT BE FITTED**.

Minimum diameter circular flues 125 mm

Minimum effective height of all class 1 (175mm) flues 3 metres

Minimum effective height of all class 2 (125mm) flues 4 metres

WARNING PASSING A SMOKE TEST IS NOT AN INDICATION THE APPLIANCE HAS PASSED A SPILLAGE TEST

BOTH TESTS ARE A SEPARATE PROCEDURE

4:2

Purpose Made Builders Opening With a Conventional Stone Flue.

With a minimum cross sectional dimension of 175mm (7") and minimum effective height of 3 metres.

The base of the builders opening must be a non-combustible material and at least 12mm thick. The Builders Opening must be at least 300mm off the floor for a wall mounted fire installation.

It is recommended that a qualified builder construct the builder's enclosure.

A lintel should be used to support the chimney breast above the Builders opening.

Any gaps around the Builders Opening, as may be the case with a dry liner wall must be sealed.

4:3

Additional Requirements for a Purpose Made Builders Opening with a Flexible Flue Liner or

A 125mm (5") diameter flexible gas flue liner with effective height of 4 metres

Conforming to B.S 715, and connected to a Register Plate fitted and sealed above the Builders Opening.

4:4

A solid flue pipe 125mm(5") diameter and metal flue box conforming to B S 715 with effective height of 4 metres

4:5

SHELF POSITION

If the fire is to be installed into a suitable fire surround it must have a fire rating of 150C.

If the fire surrounds has a combustible shelf it must be at least 300mm above the top of the fire

And protrude from the wall be no more than 150mm

For every 25mm increase in depth of combustible Shelf the position of the shelf must be raised by a further 15mm.

CF1L STANDARD AND CF1L WIDE OPENING SIZES

5:1

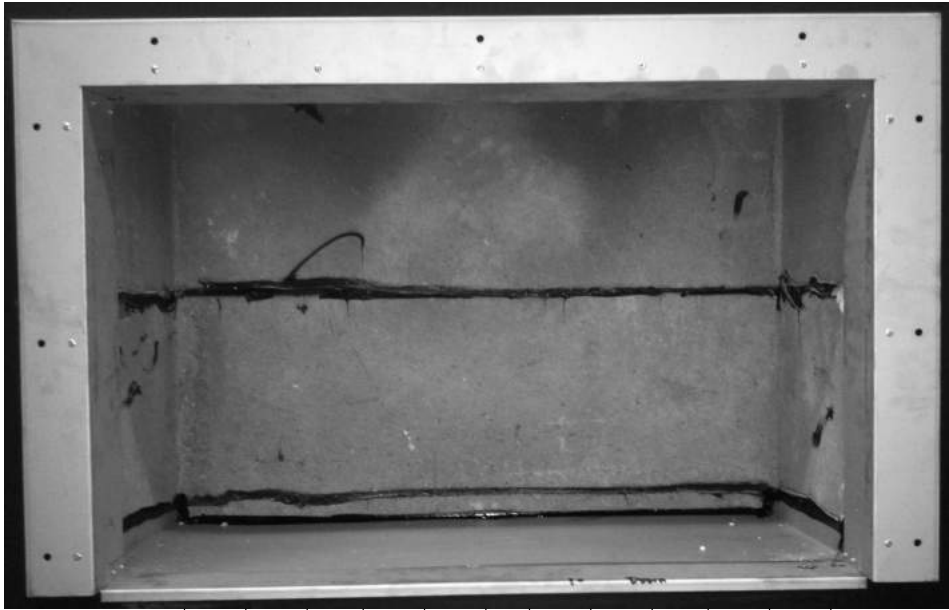

THE BUILDERS OPENING AS SHOWN ON LEFT , CRYSTAL FIRES SUPPLY A FIXING FRAME FOR THE BOSTON RANGE OF FIRES THIS MUST BE INSTALLED TO THE WALL AND SECURED , BOTH SIDES TOP AND BASE MUST THEN BE SEALED IN COMPLETELY

THE APPLIANCE GETS ITS AIR FOR COMBUSTION FROM UNDERNEATH THE TRIM SO THIS MUST STAY UNBLOCKED

↑↑↑↑↑↑↑↑↑↑↑↑↑↑↑↑
COMBUSTION AIR KEEP CLEAR

OPENING SIZES	WIDTH	HEIGHT	DEPTH
CF1L STANDARD BOSTON	770mm	490mm	340mm
CF1L WIDE BOSTON	920mm	490mm	340mm

ONCE THE BUILDERS OPENING HAS BEEN PREPARED AS SIZES ABOVE ,THE BASE MUST BE LEVELLED OFF AND FILLED IN COMPLETELY ,TO SEAL ALL GAPS , SEE PAGE 4 SHOWING DIAGRAM ON INSTALLATION

ALSO SEE 6:1 FOR SEALING IN APPLIANCE

5:2

When installed into a brick built chimney, you must ensure that there is sufficient depth to accommodate any debris, which may fall from the chimney, this depth must be sufficient to accommodate 12 litres of volumetric space in a conventional brick built chimney

5:3

This appliance is not suitable for use in fireplaces fitted with an existing chair brick , the chair brick must be removed

6:1
 mark position in the wall for installation following the current rules in force, and form an opening to the sizes stated in section 5,

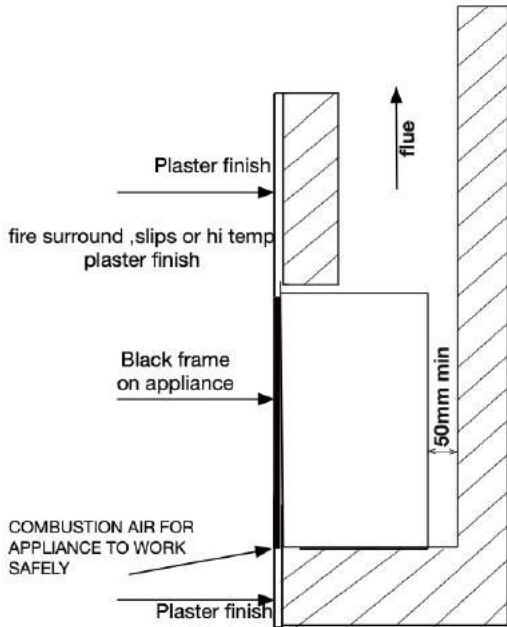

6:2
 It is important when installing the convector box that all gaps around the inside of the fireplace opening are sealed. The base both sides left and right and the rear may even need pointing in between the brickwork it is important that the flue can only pull through the flue tunnel for the appliance to clear its products and work correctly

A spillage test will deem this to be correct if a spillage test fails it will be due to the appliance not being sealed in correct

THE FITTING FRAME IS SUPPLIED IN A SEPARATE BOX WITH THE FIRE TRIM

The gas pipe is located to the left of the appliance and can be installed during the building work it should be wrapped to protect it from corrosion

6:3
 With the opening being made correctly and the fitting frame secured and sealed in place the appliance can be removed from its packaging and the glass panel removed by unscrewing the 6 screws, 3 on each side to remove black glass cover and then the 3 brackets holding in the glass panel and the glass frame can be removed ensuring the glass is supported at all times

Always place the glass panel somewhere safe away from damage

Once the glass panel has been removed and placed somewhere safe ,and the fire opening has been done the gate that allows the gas pipe to enter the appliance can be fixed open to make ease of locating it when the fire is slid into place ,

Fit the foam strips around the fixing frame

The gas appliance can now be slid into place guiding the gas pipe through the gate ,once the fire is fully pushed in secure using the screws supplied

Close the fixing gate to secure the gas pipe and stop any unwanted air going up this point

Connect the gas to the appliance and test for soundness

8.0

Installing the fuel pieces

AVAILABLE FUEL CHOICES	LOGS	PEBBLES	DRIFTWOOD
CF1L STANDARD BOSTON	YES	YES	YES
CF1L WIDE BOSTON	YES	X	X

8:1

CF1L STANDARD BOSTON LOG SETUP



The wide rear log can be placed to the back of the appliance , ensuring it is BEHIND the aeration slot at the back of the burner do not put it over the aeration slot ,the 2 sides of the log should wrap around the edge of the burner sides and sit flat ,

Once the rear log is fitted the stones can be placed around the edge of the tray but not the burner ,

The mica fill can then be placed into the burner and levelled off Only put the amount supplied into the burner

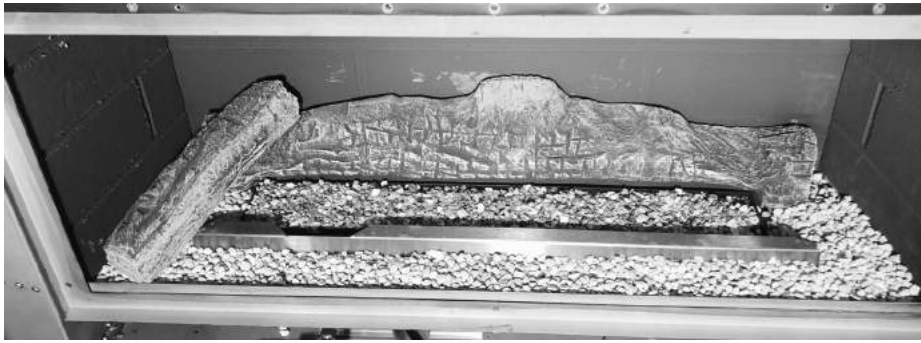

Left log can now be placed ,as shown in picture above keeping the front left as possible .



Next log vertical as shown above

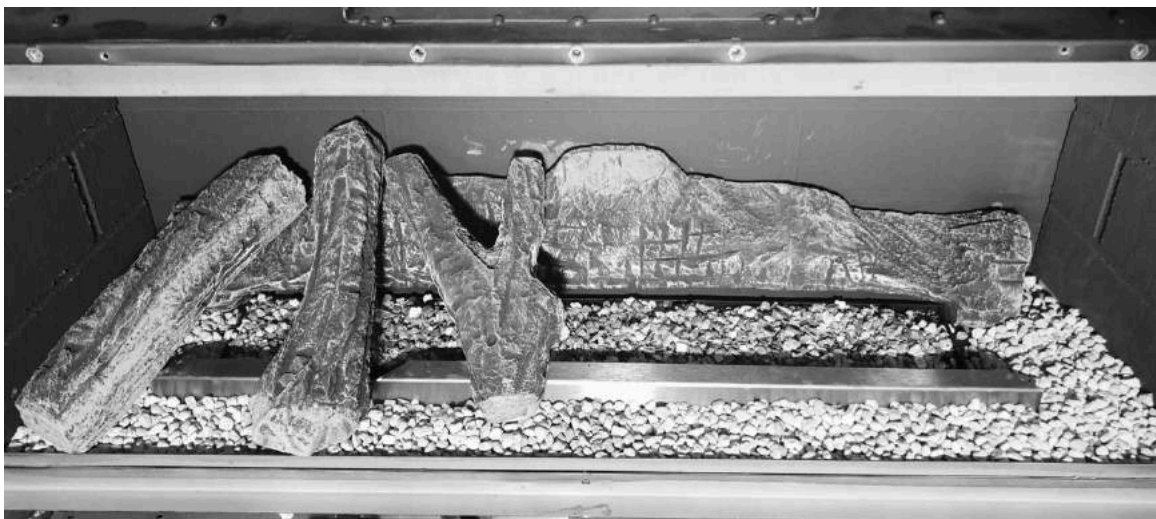

The branch log sits just to the left of centre resting on stainless base
And the big log vertical in the centre



The thinnest curved log sits to the right



The final wide branched log sits to the right with the outer branch virtually touching right side ,

Once all logs are placed in position turn on the appliance before fitting the glass .check the pilot is clear ,and check when on full the flames are coming between the logs to allow the flames to burn clean see below shown with white shapes

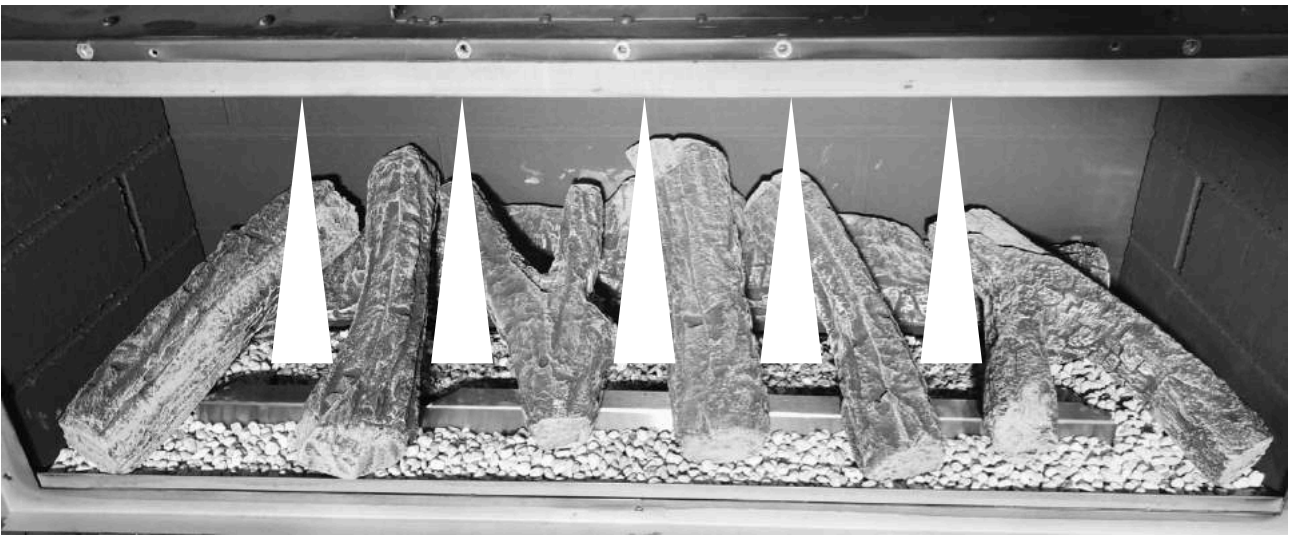

Cf11 standard Boston logs setup



The wide rear log can be placed to the back of the appliance , ensuring it is BEHIND the aeration slot at the back of the burner do not put it over the aeration slot ,the 2 sides of the log should wrap around the edge of the burner sides and sit flat ,

Once the rear log is fitted the stones can be placed around the edge of the tray but not over the burner ,

The mica fill can then be placed into the burner and levelled off Only put the amount supplied into the burner



Left log sits to left as shown above



Second log sits right of first log above & branch log below





4th LOG SITS TO RIGHT OF BRANCH AND FINAL LOG TO RIGHT



BEFORE FITTING GLASS CHECK FLAMES BURN BETWEEN LOGS ,TAP BURNER TO LEVEL MICA FIL IF NECESSARY

CF1L STANDARD BOSTON PEBBLE LAYOUT

The cf1l Boston standard can have pebbles positioned around the burner as shown below ,under no circumstances must the pebbles go in the flames or on the burner

There must be a space left so as not to cover the pilot light

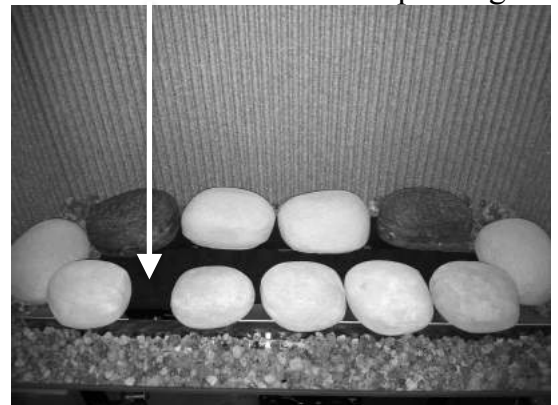

DRIFTWOOD (standard version only)

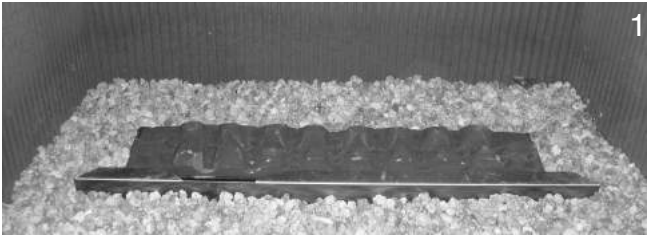

1
spread the granules around the base
**WARNING DO NOT BLOCK AIR RELIEF AT
FRONT AND BACK OF BURNER**

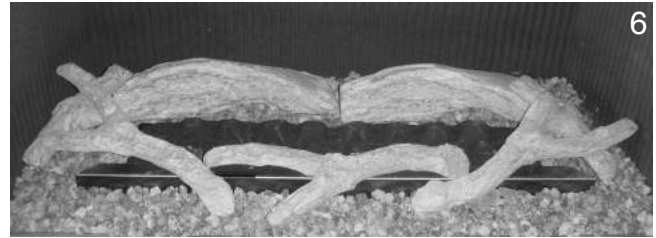

6
**CENTRE BRANCH LOG SITS BETWEEN
TWO AS SHOWN ABOVE**



2
**PLACE 2 LARGE LOGS CENTRAL TO THE
REAR OF THE FIRE
DO NOT COVER OVER AIR RELIEF SLOT**



7
**RIGHT TOP BRANCH SITS ON REAR LOG
& ON FRONT RIGHT BRANCH LOG AS
ABOVE**



3
**TWO SMALL LOGS REST AT SIDES ON
TOP OF LARGE LOGS AND RESTING ON
GRANULES**



8
**LEFT TOP BRANCH SITS ON REAR LOG
& ON FRONT LEFT LOG AS ABOVE**



4
**RIGHT SIDE BRANCH LOG RESTS ON
SIDE LOG AND GRANULES AT FRONT**



9
**FRONT CENTRE TOP LOG SITS AS
ABOVE**



5
**LEFT SIDE BRANCH LOG RESTS ON SIDE
LOG AND GRANULES AT FRONT**



REAR CENTRE TOP LOG SITS AS ABOVE

8.1

After installing the fuel pieces the glass panel can be refitted by placing the glass panel in place and refitting the 3 brackets for holding the glass and screwing them in place, The glass doorframe can now be refitted using the 6 screws

The fire can now be turned on and a spillage test performed

check for spillage



Close all doors and windows.
with the fire operating at high for 5 minutes
Insert a smoke match into the grill 25mm in central
to the flue outlets as shown above
All smoke should be drawn into the Diverter, if not
wait a further 10minutes and repeat the test.
If there are any Extraction Fans in the room or
adjoining rooms set them at maximum and with
the door to this room open repeat the above
test. If spillage still occurs Seek Expert
Advise.,

If spillage persists, the flue is not functioning correctly and a fault exists. If after investigation the fault cannot be traced and rectified, the fire must be disconnected from the gas supply and expert advice obtained.

IMPORTANT: IF THE BURNER IS EXTINGUISHED FOR ANY REASON YOU MUST ENSURE THAT YOU WAIT A FULL FIVE MINUTES BEFORE ATTEMPTING TO RE-LIGHT THE FIRE

At the time of commissioning the appliance ,complete all relevant sections of the benchmark checklist on the inside back pages of this document

Crystal fires ltd is a licensed member of the benchmark scheme which aims to improve the standards of installation and commissioning of domestic heating and hot water systems in the uk and to encourage regular servicing to optimise safety , efficiency and performance .

Benchmark is managed and promoted by the heating and hot water industry council, for more information visit www.centralheating.co.uk

9:1

Fire Control

This control is situated on your fire. The drawing shows the main features of the control.

With this appliance this valve will sit beneath the fire and the handset will be used to operate

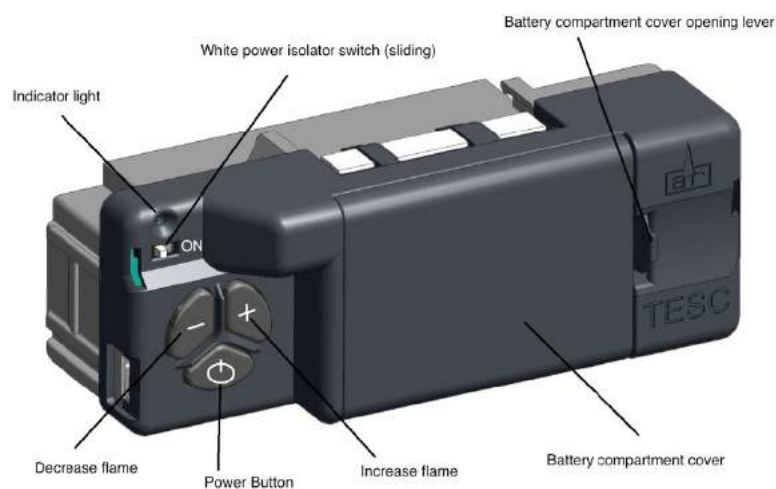

This appliance is fully remote control so the handset must be used also to operate the appliance , 3 batteries are installed in the gas valve and 2 in the handset ,

The batteries in the gas valve must be alkaline

The handset will show a wifi logo in the top right of the handset when connected

Handset

Ensure the power isolator switch on the front corner of Fire Control is in the on position I. **NOTE:** For safety reasons a button must be pressed and released for the command to be recognised. Keeping hold of a button when pressing (unless other wise instructed) will not be recognised as a command press.

Grasp around the handset to unlock its functions. The green unlock light will illuminate to show when the handset is unlocked and ready to accept commands. (N.B. Keep a grip of handset to keep it unlocked, to continue to operate the command buttons.)

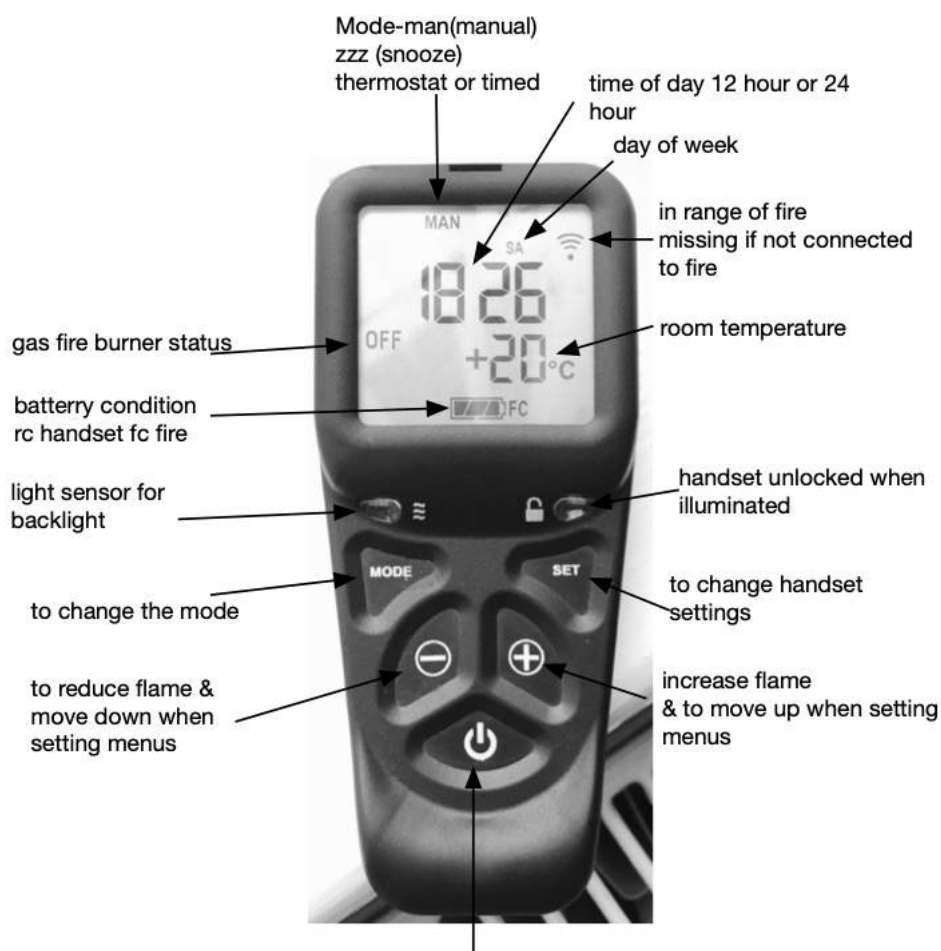

Power button – To start the fire, (after following the instructions of the previous page), with one hand grasp around the rear of both sides of the button area control. The green unlock light will illuminate. Keep the handset held to keep the control unlocked, to enable operation of the buttons. Then with the other hand touch and hold a finger on the power button for about 3 seconds. (A short beep and a flash of the unlock light will happen upon touching.) When the word "pilot" appears at the bottom left hand corner of the display, immediately release the power button. (A second flash of the unlock light and a longer beep will also sound at the time to release the power button). The Fire should be lit within a few seconds. (N.B. If power button is held for more than a few seconds after second flash/beep/word pilot appears, the command is ignored for safety reasons. Similarly if it is released too soon before the word pilot appears, the command is also ignored. With this system, the control has been designed to ensure that only intended ignition of the fire occurs.) To stop – with handset held to unlock it, press then release power button.

Operating instruction (detailed)

Upon successful insertion of the batteries in the Handset the display will be as shown. **The handset will be supplied paired to the fire** and all that is required is to set the time of day and select if a 24h hour clock or 12 hour clock display is required and if temperature display is on Celsius or Fahrenheit.



Setting the time

Holding the handset as described previously to unlock the keypad, press and hold "SET" for a few seconds and the display will be as shown

Setting the display for 12 or 24 Hour display

As always when pressing the remote control buttons keep the control held to keep the green light on and therefore handset safety feature, unlocked. The H indicates that it is time to set the timer to either 24 hour display or 12 Hour (AM or PM) display. Press the + or – button on the handset to toggle between the two settings. When you are ready to confirm the setting you want press the "SET" button to progress to setting the day of the week.



Setting the day of the week

Press and release the + and – buttons until the correct day of the week is shown on the display.

(Mo = Monday, Tu= Tuesday, We=Wednesday, Th=Thursday, Fr=Friday, Sa= Saturday and Su=Sunday).

Press “SET” to accept the day of the week and to progress to setting the Hour of the day.

Note: Whilst doing this setup pressing “SET” advances to the next display and pressing “MODE” will return you to the previous display setting.



Setting the Hour

Press and release the + or – button to change the hour to the correct hour and press set to store and to move to setting the minute.

Repeat this for setting the minutes.

hour digits flashing
the set press -minutes digits flashing



Setting the temperature display to Celsius or Fahrenheit.

Press and release the + or - button to toggle between C and F .

When the display shows the desired symbol, press and release the “SET” button to store.

As the important settings above have now been done. Press and hold (not releasing straight away) the “SET” button for a few seconds and this will exit the setup menu.(alternatively you can press and release the set button several more times until the time of day is displayed on the handset



The control is now ready for use with the Fire Control.

Note: the legend at the bottom shows the battery condition of both the batteries in the hand set and in the fire control alternately. RC = Remote Control handset and FC = Fire control. The control is designed to get the most out of the batteries but when eventually the display shows they are spent (when the battery legend is a empty area, we recommend you change the batteries in the handset before they are flat, to avoid having to re-program the time of day in again. N.B. Pairing is not lost, even if the batteries are removed or flat. The pairing is not lost when the batteries are flat but replacing them quickly before they have gone flat will avoid having to set the time of day, day of the week etc again)

Paging the handset

If you have misplaced the handset (and it is in range of the fire), you can page it by pressing the + button only on the fire control for around 5 seconds. The handset will flash and make a noise to help you to locate it. Once you pick up the TESC it knows you hold it and so the sound stops. The flashing and sound will last for 60 seconds each time the handset is paged as described. If not found in 60 seconds, page again and so on. NOTE: PRESS “+” Button ONLY , NOT “+” and “-” Together as you will accidentally break the handset pairing and have to reset handset to factory state and pair again (see other parts of the booklet if this happens).

Advanced settings Menu

In the event that you may want to change the other preset settings of the control features. Do not do a long press and hold above but a normal short press and release will take you into the advanced settings area.

Advanced settings options are:-

- Back light –
 - A = Automatic (default setting). The back light comes on in the dark but not in the light.
 - 0 = Light never comes on.
 - 1 = Light comes on when ever handset is unlocked.
- Display contrast – 8 levels from 0 to 7 (default level 4) .
- P = pairing with other devices other than the fire control. The hand set can pair with other modules to :-
 - L= Operate an electric light – which is the dimmable in 9 steps
 - F= operate an electric fan –which can have 9 speed levels
 - A= operate an auxiliary contact to operate another device.

Other Modes than Manual mode

Depending upon the model of Fire your handset maybe enabled to have some automatic features, namely, Thermostat mode, timed thermostat mode and snooze mode. Snooze mode can be selected to work with in conjunction with either manual or thermostatic modes.

You can switch between modes at any time with the handset unlocked by pressing and releasing mode button to toggle between modes.

Note: If at any time the power button is pressed during operation, this will stop the fire and exit any automatic mode and return the handset to manual (MAN) operation mode.

Snooze mode in manual operation

Snooze mode is a time period you can set which will turn off the fire after a certain time period has elapsed.

The snooze time period can be set before or during manual operation of the fire. Hold the handset to unlock as described previously and press the mode button as many times as necessary until the word MAN and the Zzz symbols are flashing at the top of the display. Press and release the set button and this will put the control into Manual snooze mode.

The default time period for the snooze time period is 1:00 hour. Pressing the set button again will show you the snooze time period remaining. This can be adjusted by pressing the “+” or “-“ buttons. The timer period that can be set is from 1 minute to 24:00 hours.

After adjusting the time, press set again to enter the time setting required (or if left for a few seconds this time is now stored and used).

Once this countdown timer has reached zero the fire will turn off (as if you had pressed off manually, it does not recycle).

Snooze mode in Thermostatic mode

The same thing as above can be done before or during a thermostatic mode operation (see below).

Thermostatic mode for closed fires

The handset has within it a thermostat sensor and this can be set so the fire will heat the room to match the temperature set in the handset.

There are 3 temperature types that can be set:-

-Day mode temperature that has a sun symbol on the display – the default temperature is 24 C

- Night temperature that has a half moon symbol on the display- the default temperature setting is 18 C

-frost protection that has a snowflake symbol on the display – the default temperature setting is 5C

Hold handset and press and release the mode button several times as necessary until the display has a thermometer symbol flashing at the top of the display. Press the set button to enter this mode.

Press the set button again to see the temperature setting that is set and the mode (the default is 24 C) and on the left of the display is a sun symbol showing it's the day temperature.

If a different set temperature is required, while the display is showing this set temperature , press the + and – buttons to alter the setting. When finished either press set or leave and after a few seconds the new setting will be accepted and the display will return to the time of day screen.

On the anniversary of the set minute of the clock, the set temperature will be compared to the actual temperature displayed on the handset(i.e. the room ambient temperature around the handset). If the room temperature is higher than the set temperature the fire will not light until the room has cooled to below the set temperature. The fire would then automatically turn itself on when the room is cooler than the set temperature and down and off if necessary when it is hotter than the set temperature.

(Note- when the set temperature is reached while the fire is in operation, the fire reduces the burner power level each minute until the burner is off. The pilot (if fitted) will remain on for a further 30 minutes and if the set temperature is still too high , the pilot will then also extinguish. When the set temperature is higher than the actual temperature , the fire will automatically light and go to the full burner rate to reheat the room back to the set temperature.

Note: If at any time the power button is operated during Thermostat mode, the control will cancel any thermostat operation and return the control to manual mode

For ease of setting there are two other modes that can be selected as stated above. Night mode (moon symbol) and frost protection setting (a snow flake). These can be selected (and adjusted if necessary) by pressing set then mode while in thermostat mode. Pressing mode button toggles through from day to frost modes. The purpose of these settings is to help your fire to automatically protect you home against becoming too cold if there is a sudden change in the weather. The control must be left in the appropriate mode for this to function.

Note: As stated in an earlier section, snooze function can also be operated in conjunction with thermostat mode. The thermostat symbol and the Zzz symbol will be on together when in this mode.

Thermostat mode for open fires

This is the same as for closed fires except that :-

The fire will not ignite automatically and it will only regulate between minimum and maximum burner setting. The fire is lit manually by the remote control and then you enter thermostat mode as described above and set the temperature. When no longer requiring thermostat mode. Turn off the burner as described above and the handset returns to manual mode.

Timed thermostat mode(Closed fires Only)

This mode enables the various day, night and frost thermostat modes to be set on a program timer. The control will work as a thermostat switching between the day, night and frost temperature settings in line with the program set.

The set up of the timer will be shown by a demonstration.

To set up the timed thermostat to be at 24 C from 06:00 to 09:00 then drop to 18 C from 09:00 to 15:30 and then 24 C again from 15:30 until 23:30 and then to protect from frost a 5 C setting between 23:30 to 06:30 the next day from Monday to Friday this is what you would do:-

Hold handset to unlock – press set and hold until a beep and release. Press MODE button until the timer symbol is flashing on the top of the display – press set to enter the time mode – Mo is flashing so it is already set for Monday- press SET and release now press the + and – buttons to make the time of day read 06:00(note the steps are in 15 minutes steps) – press SET and release- press + and – to make the next symbol show a flashing sun symbol- press and release SET- as Mo is flashing press and release SET again enter the next time of 09:00- press and release SET- change the flashing sun symbol to a flashing moon symbol by pressing and releasing the + and – buttons then press and release SET again to store the moon setting (18 c)- continue this until you have entered each time and temperature change required for each day.

To put the fire into thermostat timer mode press and release the mod button until the thermostat and timer symbols are displayed on the display at the top. Press and release the “SET” button and the control will now run the timed program set up in the memory.

To adjust any time setting in the memory re enter the timer program setup mode (by pressing SET and then MODE as described above). Then press set to make the time flash. Now holding the + button advances the display to the next setting and so on throughout the program. Amend the appropriate setting and when finished do a long press of the SET button to exit the program mode.

To reset the whole timer program in the memory:-

Hold handset- press set- press mode until SETUP is flashing- press SET to enter SETUP- press SET about 8 times until CP0 is flashing on the display- use the + and – buttons to change the display to CP1 – press SET – press SET again and the display will return to standby Manual mode and the timer setting have been completely removed for the timer memory.

MANUAL GAS VALVE OPERATION

OPERATING INSTRUCTIONS.

THE APPLIANCE DATA BADGE IS POSITIONED ON THE FRONT BOTTOM SECTION OF THE APPLIANCE AND CARRIES THE CONTROL KNOB POSITIONS.THE FULL LIGHTING PROCEDURE IS AS FOLLOWS.

1.PUSH CONTROL KNOB IN AS FAR AS POSSIBLE ON GAS CONTROL

2.TURN KNOB ANTICLOCKWISE TO IGNITION POSITION STILL KEEPING KNOB IN AS FAR AS POSSIBLE.

3.THE IGNITION BUTTON WILL IGNITE THE PILOT WITH THIS OPERATION KEEP THE KNOB PRESSED IN FOR 15 SECONDS.IF THE PILOT FAILS TO LIGHT TURN THE CONTROL KNOB CLOCKWISE TO THE OFF POSITION, WAIT 3 MINUTES AND REPEAT THE PROCEDURE

4.WHEN THE PILOT FLAME IS ALIGHT THE CONTROL KNOB SHOULD BE ALLOWED TO SPRING OUT SLIGHTLY.TURN THE KNOB FULLY ANTICLOCKWISE TO THE HIGH POSITION.THE PILOT FLAME WILL THEN IGNITE THE MAIN BURNER.THE PILOT FLAME CAN BE VIEWED TO THE RIGHT OF THE FIRE JUST BEHIND THE FRONT LOG SET

5.THE APPLIANCE CAN BE ADJUSTED BETWEEN HIGH AND LOW BY MOVING THE CONTROL KNOB TO SUIT,THE KNOB WILL NEED TO BE DEPRESSED SLIGHTLY TO MOVE FROM LOW HIGH AND IGNITION.

6.TO TURN THE FIRE OFF,DEPRESS THE KNOB SLIGHTLY AND TURN IT TO PILOT POSITION.

7.TO COMPLETELY EXTINGUISH THE FIRE DEPRESS THE KNOB SLIGHTLY AND TURN TO OFF POSITION.

8.SHOULD THE SPARK IGNITION FAIL TO OPERATE.TURN THE CONTROL KNOB TO THE OFF POSITION AND WAIT 3 MINUTES.TURN THE KNOB TO THE IGNITION POSITION AND THEN LIGHT THE PILOT WITH A TAPER."LIGHTING THE PILOT WITH A TAPER IS AN EMERGENCY MEASURE ONLY AND THE APPLIANCE SHOULD BE SERVICED AS SOON AS POSSIBLE".

IMPORTANT .THIS APPLIANCE IS FITTED WITH AN OXYGEN DEPLETION SENSOR INCORPORATED INTO THE PILOT BODY.SHOULD THE FIRE REPEATEDLY EXTINGUISH ITSELF THEN SPECIALIST ADVISE SHOULD BE SOUGHT,AS THIS MAY INDICATE SPILLAGE INTO THE ROOM OF COMBUSTION PRODUCTS.

INSTRUCT THE USER

10.0

Instruct the user on the safe operation of the appliance.

Demonstrate how to operate the Remote Control System. OR MANUAL VERSION

Explain the function of the ODS as described earlier.

Any cleaning procedures should only be undertaken with the appliance cold.

Show the Customer how to gain access to the Glass Door for cleaning on the Outside and how to gain access to the Inside for cleaning.

Advise the customer that the fire must never be used with the Door Open or if the Glass Panel is found to be cracked Chipped or damaged.

Hand all the Instructions to the user for safekeeping and future reference.

Advise the Customer that the Batteries in the Remote Control Hand Set and Receiver must be replaced When the appliance is serviced

Advise the customer that the flue and fire should be serviced Annually for continued safe operation

Certain wall coverings like blown vinyl should not be used on the wall above the fire

MAINTENANCE

11:1

Any cleaning should be carried out when the appliance is cold the fire will retain heat for some time after it has been switched off

11:2

If any fuel pieces is seen to be broken or damaged replacements must be obtained from the supplier

If soot is seen to be building up on the fuel pieces it is indicating that the fire requires servicing

11:3

Due to the nature of the convection air flowing over the fire, The walls of the room directly and around and above the fire may become discoloured slightly

CERTAIN WALL COVERINGS LIKE BLOWN VINYL SHOULD NOT BE USED ON THE WALL AROUND THE FIRE

Again ensure the fire and glass panel are cold before proceeding.

Like all glass windows the glass will become dirty and require cleaning.

The glass door can be cleaned on both the outside and inside with a damp cloth, allowed to dry then wiped with a Dry cloth to remove smears. To do this Remove the 2 screws at the top and bottom Left and top and bottom right Hand side and remove, the glass will pull forward at the bottom and pull out of the channel at the top, replace in reverse order

Important.

After cleaning it is important that the Glass Door is sealed closed with the fixing screws.

If the Glass Door Panel is found to be Cracked, Chipped or Damaged the Fire Must Not Be used until it has been replaced

Important do not disturb the fuel pieces

For spares and service contact your local supplier or installer stating the model and serial number

Regular service and inspection should be undertaken to ensure continued safe operation, it is recommended that your fire and flue should be checked and serviced annually by a competent person for continued safe operation

SERVICING

12:0

GENERAL CHECKS PRIOR TO ANY SERVICING

A COMPETENT PERSON WITH A CURRENT GAS SAFE APPROVAL MUST SERVICE THE APPLIANCE EVERY YEAR

A GAS SOUNDNESS TEST BE CARRIED OUT PRIOR TO SERVICING

IT IS ALSO RECOMMENDED THAT THE OPERATION OF THE APPLIANCE CHECKED PRIOR TO ANY SERVICING, AFTER THESE CHECKS ENSURE THE APPLIANCE IS COLD BEFORE ANY SERVICING BEGINS

12:1

General servicing

It is recommended that the ods and mica fil are replaced during any servicing, please ensure they have been purchased before servicing begins

Lay a dust-sheet in front of the fire

Remove screws holding glass frame

Pull glass away at TOP corners and remove glass panel, inspect for damage and store in a safe place

Remove FUEL PIECES and check for any soot clean as necessary

The appliance can be unscrewed from the fixing frame and pulled out ,the catchment space can then be cleaned of debris or soot ,

The firetray can be removed by unscrewing it from the box and carefully lift out , clean the burner ports and any dust by the injector

Vacuum the inside of the firebox before replacing the fire tray

Replace burner and the screws holding it down

Replace the fuel using the instructions

Replace the glass panel and screw up the glass fixing frame

Check any faults have been corrected and re-commission the fire conducting the usual safety checks specifically gas soundness checks and spillage

Checking the gas rate and pressure would ensure the appliance has not changed since installation

WARNING

This appliance is a heating appliance and as with all heating appliances a fireguard should be used for the protection of children, the elderly and infirm. Fireguards should conform to B.S. 8423 : 2002 (Fireguards for use with gas heating appliances).

PART	PART NUMBER
HANDSET WITH DISPLAY	CONNELLY 01
ODS	CONNELLY02
INJECTOR 500	CONNELLY03
GLASS PANEL AND SEAL	CONNELLY04
TESC GAS VALVE	CONNELLY05
Erta ods 82 330	CONNELLY06
Mica fil curve	CONNELLY07
Curved glass	CONNELLY08

TERMS & CONDITIONS
THE APPLIANCE MUST HAVE A GAS NOTIFICATION

AS OF 01/03/2016 BENCHMARK FORM MUST BE FILLED IN COMPLETELY AT TIME IF INSTALLATION
Two Year Parts & Labour Guarantee.

Crystal Fires Ltd guarantees your fire for two years against defective manufacturing and material, including parts and labour, subject to the following terms and conditions.

Further Three Year Parts Only Guarantee.

Your Crystal Fire is covered for a further three years for parts only against defective manufacturing and materials, subject to the following terms and conditions.

1. This guarantee applies to gas fires only. Electrical appliances are not included.
2. Installation must be carried out by a qualified Gas Safe Registered engineer, in accordance with the supplied instructions and a gas safety certificate must be issued by the installer. The product must be operated in accordance with the supplied instructions.
3. The enclosed guarantee registration form must be fully and correctly completed and returned to Crystal Fires within 14 days of the installation.
4. The fire must be serviced annually by a Gas Safe Registered engineer and a gas safety certificate must be issued by the engineer, irrespective of the amount of use of the appliance. The service must include replacement of the oxypilot assembly.
5. The appliance must be kept free from dust, dirt and debris by the user, in accordance with the cleaning instructions.
6. This guarantee is non-transferable and is made to the original owner provided that the purchase was made through an approved Crystal Fires stockist.
7. This guarantee is limited to the repair or replacement of parts found to be defective in material or workmanship after confirmation of the defect by a Crystal Fires engineer, provided that such parts have been subjected to normal conditions of use.
8. Any installation, labour, transportation or any other related costs or expenses arising from defective parts, repair or otherwise of same, are not covered by the guarantee, nor shall Crystal Fires assume responsibility for them. Furthermore, Crystal Fires will not be responsible for any incidental, indirect or consequential damages, except as provided by law.
9. All other guarantees – expressed or implied – with respect to the product, its components and accessories or any obligations or liabilities on the part of Crystal Fires are hereby expressly excluded.
10. Crystal Fires neither assumes nor authorises any third party to assume on its behalf, any other liabilities with respect to the sale of this Crystal Fire appliance.
11. This guarantee does not apply to any other product not manufactured by Crystal Fires, such as prefabricated flue boxes and flues.
12. Crystal Fires will not be responsible for:-
 1. Down drafts or spillage caused by environmental conditions such as nearby trees, buildings, rooftops, hills or mountains.
 2. Inadequate ventilation or negative air pressure caused by mechanical systems such as extraction fans, cooker extraction hoods, clothes dryers etc.
13. This guarantee is void if:-
 1. The appliance has been operated in atmospheres contaminated by chlorine, fluorine or other damaging chemicals.
 2. The appliance is subjected to prolonged periods of dampness or condensation.
 3. Any damage to the combustion chamber, heat exchanger or other components due to water or Weather damage which is the result of, but not limited to, improper chimney/venting insulation.
 4. Any alteration, wilful abuse, accident or misuse of the product.
14. This guarantee does not apply to:-
 1. Parts that need to be replaced on a routine basis e.g. coals.
 2. Cosmetic blemishes to polished metal and painted surfaces.
 3. Surface crazing to fibre liners.
 4. remote control handsets, switch panels or receivers or discolouring or marking on glass

Benchmark Commissioning and Servicing Section

It is a requirement that the gas fire is installed and commissioned to the manufacturers instructions and the data fields on the commissioning checklist completed in full.

To instigate the guarantee the gas fire needs to be registered with the manufacturer within one month of the installation.

To maintain the guarantee it is essential that the gas fire is serviced annually by a Gas Safe registered engineer. The service details should be recorded on the Benchmark Service Interval Record and left with the householder



www.centralheating.co.uk

GAS FIRE COMMISSIONING CHECKLIST

This Commissioning Checklist is to be completed in full by the competent person who commissioned the gas fire as a means of demonstrating compliance with the appropriate Building Regulations and then handed to the customer to keep for future reference.

Failure to install and commission according to the manufacturer's instructions and complete this Benchmark Commissioning Checklist will invalidate the warranty. This does not affect the customer's statutory rights.

Customer name:		Telephone number:	
Address:			
Gas Fire make and model:			
Gas Fire serial number:			
Commissioned by (PRINT NAME):		Gas Safe register number:	
Company name:		Telephone number:	
Company address:			
		Commissioning date:	
To be completed by the customer on receipt of a Building Regulations Compliance Certificate*			
Building Regulations Notification Number (if applicable):			
Site Requirements		Yes	N/A
Was the chimney checked to ensure it only serves one flue/fire?			
Has the chimney been checked for obstructions?			
Has any debris at the base of the chimney been removed?			
For brick chimney installations is there enough depth for 12 litres of debris?			
Have damper and register plates been removed or locked in the open position?			
If previously used for solid fuel has the chimney been thoroughly swept?			
If the chimney is pre-cast has the inside of the flue been checked for extruded cement / sealant which must be removed?			
Has the fire place been checked for under-floor air supply which must be sealed off?			
Has the chimney been inspected prior to fitting the gas fire to ensure that it is in good condition?			
Has the structure of the chimney been checked for leakage using a smoke pellet test? (See BS5440-1 for details).			
Ventilation			
Does the installation require any additional ventilation requirements as detailed in the manufacturer's instructions?			
Hearth Requirements			
Is the hearth constructed from non-combustible material?			
Is the hearth a minimum of 13mm thick and the top surface at least 50mm above the floor?			
The hearth is a minimum of 760mm wide and has 300mm projecting from the fire opening?			
Firebox			
Have all non-used gas supply apertures been sealed (IMPORTANT OPERATION)?			
Has the fuel bed, coals, pebbles etc. been fitted to manufacturer's instructions?			
Gas Supply			
Has a pressure drop test been completed prior to breaking into the gas supply?			
Has an isolation tap/restrictor inlet elbow been fitted prior to servicing?			
Has the gas supply been thoroughly purged prior to connection to remove any debris?			
Gas tightness test completed and passed?			
Record burner gas pressure reading – if only the supply pressure is available a gas rate must be undertaken.			
Clearance Of Combustion Product			
Installation passes smoke match test?			
Installation			
Has the gas fire been installed and commissioned in accordance with manufacturer's instructions?			
The operation of the fire and controls have been demonstrated and understood by the customer?			
The manufacturer's literature, including Benchmark Checklist and Service record has been explained and left with the customer?			
Commissioning Engineer's Signature			
Customer's Signature (To confirm satisfactory demonstration and receipt of manufacturer's literature)			

*All installations in England and Wales must be notified to be Local Authority Building Control (LABC) either directly or through a Competent Persons Scheme. A Building Regulations Compliance Certificate will then be issued to the customer.



SERVICE RECORD

It is recommended that your heating system is serviced regularly and that the appropriate Service Interval Record is completed.

Service Provider

Before completing the appropriate Service Record below, please ensure you have carried out the service as described in the manufacturer's instructions. Always use the manufacturer's specified spare part when replacing controls.

SERVICE 01	Date:
Engineer name:	
Company name:	
Telephone No:	
Gas safe register No:	
Comments:	
Signature	

SERVICE 02	Date:
Engineer name:	
Company name:	
Telephone No:	
Gas safe register No:	
Comments:	
Signature	

SERVICE 03	Date:
Engineer name:	
Company name:	
Telephone No:	
Gas safe register No:	
Comments:	
Signature	

SERVICE 04	Date:
Engineer name:	
Company name:	
Telephone No:	
Gas safe register No:	
Comments:	
Signature	

SERVICE 05	Date:
Engineer name:	
Company name:	
Telephone No:	
Gas safe register No:	
Comments:	
Signature	

SERVICE 06	Date:
Engineer name:	
Company name:	
Telephone No:	
Gas safe register No:	
Comments:	
Signature	

SERVICE 07	Date:
Engineer name:	
Company name:	
Telephone No:	
Gas safe register No:	
Comments:	
Signature	

SERVICE 08	Date:
Engineer name:	
Company name:	
Telephone No:	
Gas safe register No:	
Comments:	
Signature	