

bemodern

FIRES | FIREPLACES

Instructions For Installation & Operation

**Model: 4306-22", 4351-30", 4304-36"
4352- 42", 4353-50"**

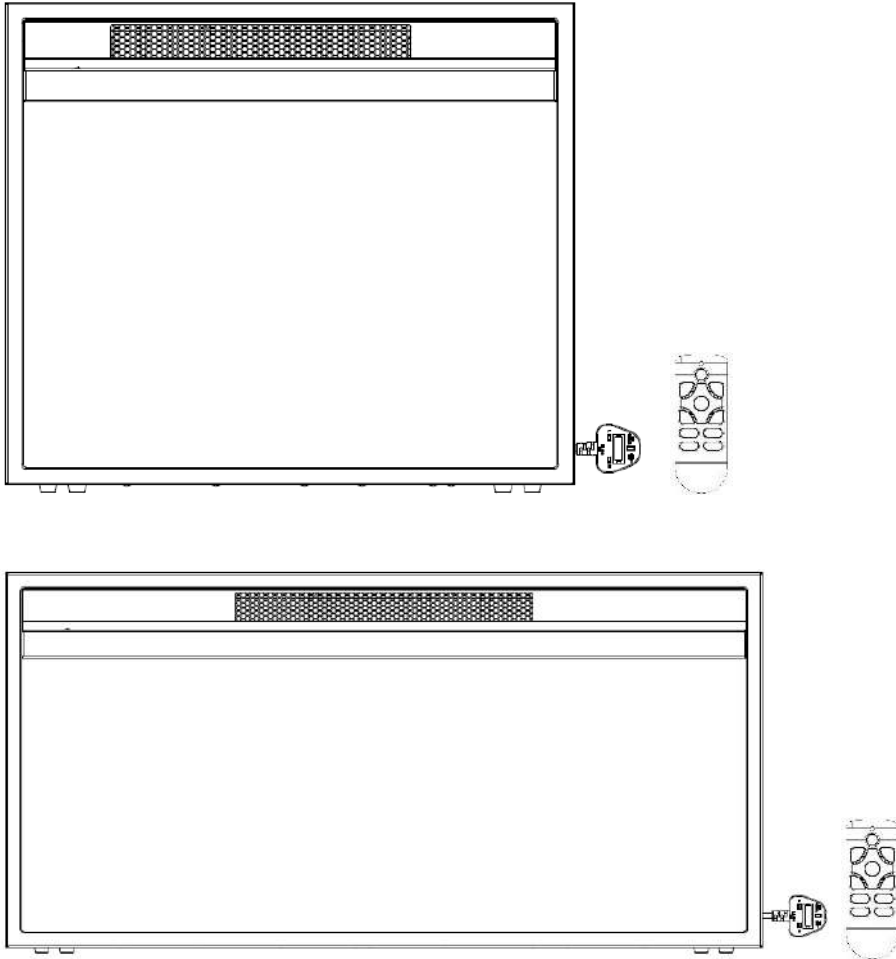

Contents

	Page
Technical Specification	2 - 3
Important Safety Information	4 - 5
Contents of the Box(es)	6
Installation Preparation	7
Installing The Fire	8-9
User Instructions - Introduction	10
User Instructions - Manual Control	11
User Instructions - Remote Control	12-14
Maintenance & Troubleshooting	15
General information	16

Technical Specification

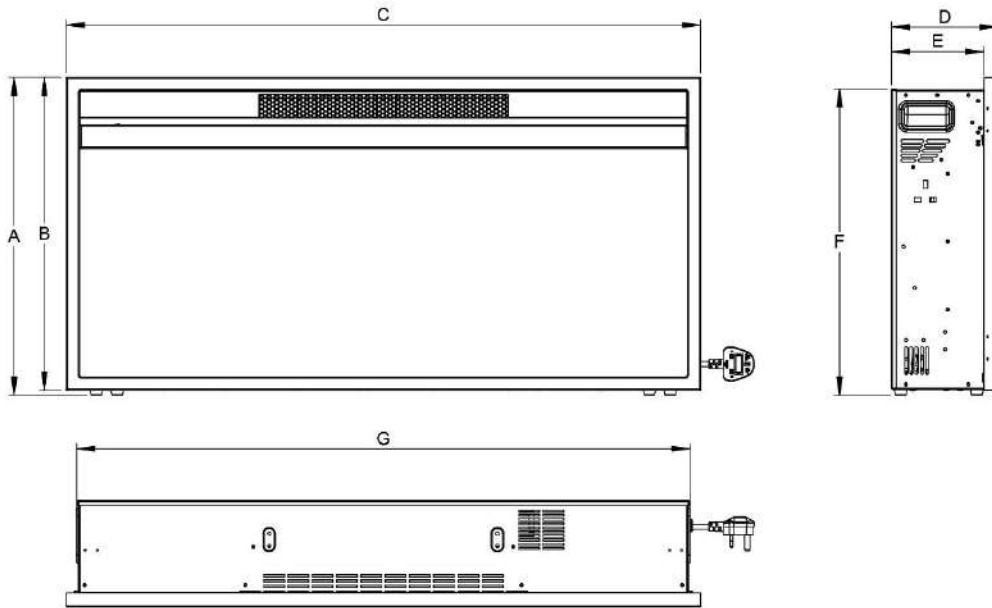

Fire	Dimensions (mm)						
	A	B	C	D	E	F	G
22" - 4306	503	495	584	154	133	487	554
30" - 4351	459	452	762	154	133	442	732
36" - 4304	459	452	914	154	133	442	885
42" - 4352	459	452	1067	154	133	442	1037
50" - 4353	459	452	1250	154	133	442	1220

Fire	Visible Glass Area (mm)		Boxed Weight	Unboxed Weight
	W	H	(Kg)	(Kg)
22" - 4306	548	375	13	11.1
30" - 4351	724	330	14.2	13.1
36" - 4304	876	330	18	15.4
42" - 4352	1029	330	18.4	17.4
50" - 4353	1212	330	21.7	19.4

Tolerance +/- 1mm

Technical Specification *Continued*....

Model No: 22" (4306), 30" (4351), 36" (4304), 42"(4352), 50"(4353)

Supply Voltage: AC 230-240V 50Hz, Maximum power consumption: 2024W.

Model:	4306	4351	4304	4352	4353
Power for Flame Effect	7w	17w	12w	21w	24w
Power for Fuel Bed	N / A	N / A	N / A	N / A	N / A
Power for Down Light	N / A	N / A	N / A	N / A	N / A
Power for Mood Light	N / A	N / A	N / A	N / A	N / A

Heat Output					
Model	4306	4351	4304	4352	4353
Nominal heat output (Pnom)	2000w	2000w	2000w	2000w	2000w
Minimum heat output (indicative) (Pmin)	1000w	1000w	1000w	1000w	1000w
Maximum continuous heat output (Pmax)	2000w	2000w	1500w	1500w	1500w

Auxiliary Electricity Consumption					
Model	4306	4351	4304	4352	4353
At nominal heat output (elmax)	13w	13w	13w	13w	13w
At minimum heat output (elmin)	13w	13w	13w	13w	13w
In standby mode (elSB)	0.3w	0.3w	0.3w	0.3w	0.3w

Type of heat output / room temperature control

Single stage heat output and no room temperature control	No
Two or more manual stages, no room temperature control	No
With mechanic thermostat room temperature control	No
With electronic room temperature control	No
Electronic room temperature control plus day timer	No
Electronic room temperature control plus week timer	Yes

Other Control Options

Room temperature control, with presence detection	No
Room temperature control, with open window detection	No
With distance control option	No
With adaptive start control	Yes
With working time limitation	No
With black bulb sensor	No

Important Safety Information

Read all the instructions carefully before using the appliance.

For indoor use only. This appliance is not suitable for use outside the house and only suitable for well insulated spaces or occasional use.

If the fire is to be placed in front of an existing chimney opening and there is any risk of chimney debris falling down onto the fire or drafts from the chimney it is recommended that the flue or opening is sealed off with non-combustible non-fibrous insulation materials. Do not place into an existing fireplace that is prone to dampness. Should it be necessary to cap and seal the chimney to prevent personal injury, a professional should be hired to do the work

Do not use this appliance in the immediate surroundings of a bath, a shower or a swimming pool.

Do not use this fire as a free-standing appliance. It must always be fixed to the wall, fireplace mantel, floor etc.

This fire must not be located immediately below a socket-outlet.

This appliance must be earthed.

This appliance must not be supplied through an external switching device, such as a timer, or connected to the circuit that is regularly switched on and off by utility in order to avoid a hazard due to the inadvertent resetting of the thermal cut out.

A non-rewireable plug fitted with a 13A fuse is supplied. Should the fuse or plug need replacing, and you are competent to do so, it must be replaced with a 13A fuse or plug being 13A BS1363A approved.

If the power cord is damaged, it must be repaired by the manufacturer, its authorised service centre or professional person.

The meaning of this symbol  is **DO NOT COVER** **Warning:** in order to avoid overheating, do not allow the appliance to be covered or let the air inlet/outlet become obstructed.

To reduce the risk of fire, keep textiles, curtains, or any other flammable material a minimum distance of 1 meter from the air outlet.

Keep the power cord away from hot surfaces and hot conditions. Do not route the power lead in front of the appliance.

Do not use this fire in rooms that have explosive fumes in them (for example petrol), or if you are using solvents, glue, aerosol spray or in flammable paints, as these may catch fire.

This appliance can be used by children aged from 8 years and above and persons with reduced physical, sensory or mental capabilities or lack of experience and knowledge if they have been given supervision or instruction concerning use of the appliance in a safe way and understand the hazards involved.

Children and vulnerable people must be supervised at all times when using this appliance, as some parts can become very hot and cause burns.

Do not use this appliance in small rooms when they are occupied by persons not capable of leaving the room on their own, unless constant supervision is provided.

Important Safety Information *Continued.....*

Cleaning and user maintenance shall not be made by children without supervision.

Children aged from 3 years and less than 8 years only can switch on / off the appliance provided that it has been placed or installed in its intended normal operating position and instructions and supervisions concerning the safe way of the use of the appliance are offered. Children aged from 3 years and less than 8 years shall not plug in, regulate and clean the appliance or perform user maintenance.

This appliance shall not be played with by children.

Children of less than 3 years should be kept away unless continuously supervised.

Keep the power plug accessible after installation.

Manual Handling

BEFORE STARTING THE INSTALLATION OF THIS FIRE, PLEASE READ THE FOLLOWING:

CAUTION: This appliance is heavy. Always seek assistance whilst unpacking and / or during installation.

The installation should be carried out by **two adults** to avoid injury or damage. If for any reason it is considered too heavy, please obtain assistance.

Always use the handles on the rear of fire where possible.

When lifting the electric appliance, always keep your back straight. Bend your legs and not your back. Avoid twisting at the waist. It is better to reposition your feet.

Avoid upper body / top heavy bending. Always bend from the knees rather than the waist. Do not lean forward or sideways while handling the fire.

Always grip the fire with the palm of the hand – do not use the tips of fingers for support.

Always keep the fire as close to the body as possible. This will minimize the cantilever action.

Use gloves to provide additional grip.

Contents of the box(es)

Box- (22" - 4306)

Quantity	Description
1	22"- Electric Fire Engine
1	Fire Remote Control & 2 X AAA Batteries
1	1 Trim Fitted to the Fire with 8 x 2mm Magnets.

Box- (30" - 4351)

Quantity	Description
1	30"- Electric Fire Engine
1	Fire Remote Control & 2 X AAA Batteries
1	Trim (Fitted to the Fire with 12 x 2mm Magnets.)

Box- (36" - 4304)

Quantity	Description
1	36"- Electric Fire Engine
1	Fire Remote Control & 2 X AAA Batteries
1	Trim (Fitted to the Fire with 12 x 2mm Magnets.)

Box- (42" - 4352)

Quantity	Description
1	42"- Electric Fire Engine
1	Fire Remote Control & 2 X AAA Batteries
1	Trim (Fitted to the Fire with 12 x 2mm Magnets.)

Box- (50" - 4353)

Quantity	Description
1	50"- Electric Fire Engine
1	Fire Remote Control & 2 X AAA Batteries
1	Trim (Fitted to the Fire with 12 x 2mm Magnets.)

Please ensure all fixings are present before commencing installation. If anything is missing please call Customer Services on 01914300901 or email us at customerservices@bemodern.co.uk

Installation Preparation

Before the fire can be fitted a suitable opening needs to be made. **See Diagram 1.**

If installing into a stud wall, the stud wall must include a **header** as specified in the following diagrams. This is to ensure that the weight of the finished wall is not resting on top of the fire. The base of the opening / stud work must also be able to take the full weight of the appliance.

The fire should be positioned on a firm level surface and in a clean 'dust free' environment. If fitted into an open chimney, the chimney must be blocked off to reduce the risk of draught and damp through the fire, which may cause the safety cut out system in the fan heater to operate.

Note: Any protruding headers MUST be made of a non-combustible material.

If installing into an opening with a finished face material of MDF or MFC, please ensure all internal dimensions are adhered to. **See Diagram 2.**

Required Opening & Minimum Internal Dimensions

REQUIRED Opening Dimensions (mm)			Rebate (mm)
FIRE	A	B	C
22" (4306)	495	558	145*
30" (4351)	450	736	145*
36" (4304)	450	888	145*
42" (4352)	450	1041	145*
50" (4353)	450	1224	145*

Note: Ensure there is a minimum 12mm clearance between the fire and the wall behind.

*Dimension includes required 12mm Clearance.

MINIMUM Internal Dimensions (mm)		
FIRE	D	E
22" (4306)	505	612
30" (4351)	460	790
36" (4304)	460	942
42" (4352)	460	1095
50" (4353)	460	1278

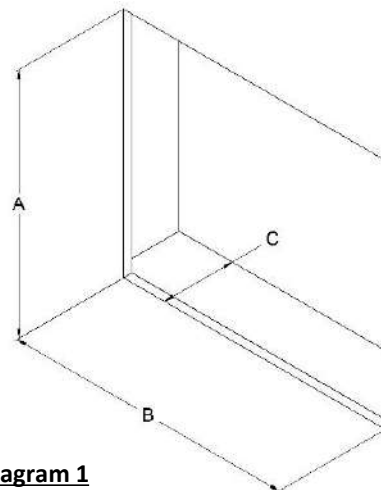

Diagram 1

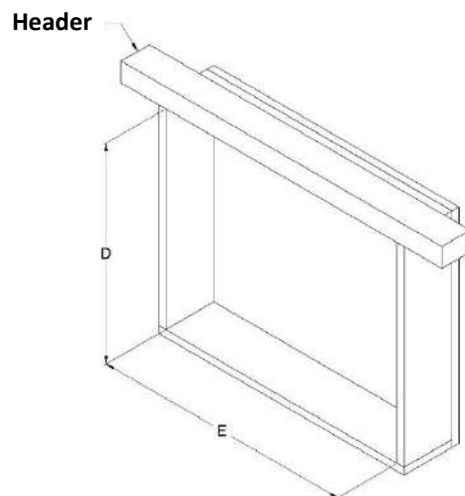

Diagram 2- Face Material removed.

Installing the Fire

Note: The fire is a two adult person lift. A second person will be required to lift and support the fire during installation.

Before the fire can be installed, consideration will need to be given to routing the power supply to the fire. This will affect the stages of the installation process. We advise a qualified electrician conduct any electrical parts of the installation.

Note: An accessible single socket is required for the operation of the fire.

Unpack your new fire- **DO NOT** dispose of the packaging until you have checked and made sure all the parts and fixings listed on **Page 6** are present.

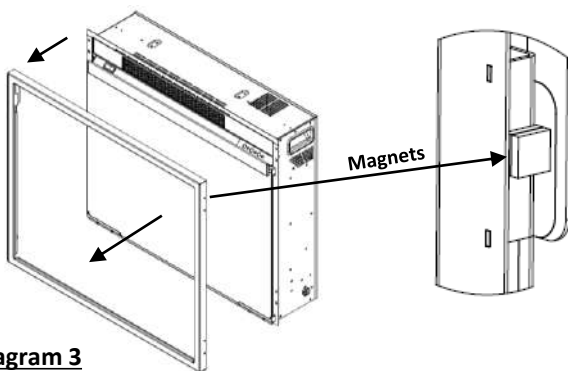

Diagram 3

Once the fire is unpacked remove the **Trim**, this is magnetised to the **Fire**.

Note: The quantity of magnets supplied depends on the size of fire purchased. See **Page 6**.

See **Diagram 3**.

Note: The fire is a two adult person lift.

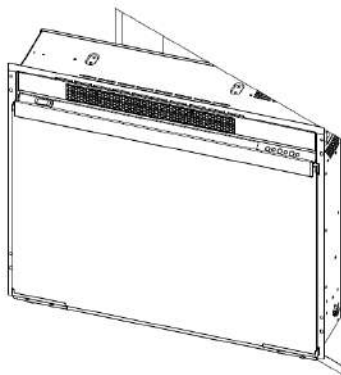

Diagram 4

Ensure the **Fire** is connected to a power supply and then angle the **Fire** into the opening.

Tip: Angle the side with power cable protruding into the opening first.

See **Diagram 4**.

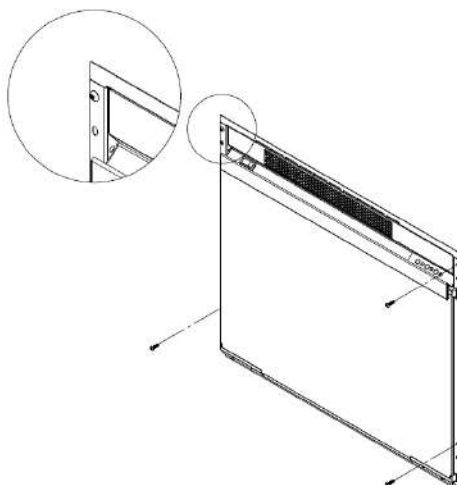

Diagram 5

Fix the **Fire** to the face material using the **4** fixing points indicated in **Diagram 5**.

Note: Fixings are not provided.

IMPORTANT NOTE:

Fixings (i.e. screws/wall plugs etc.) are not supplied as these are crucially dependent upon the type of wall and surface the Fire is going to be fixed too. The installer is therefore responsible for ensuring that suitable fittings are used as well as individual fitting situations and environments. All mechanical fixings, for holding the Fire in position, must be secured to a solid wall or structure.

Installing The Fire *Continued*.....

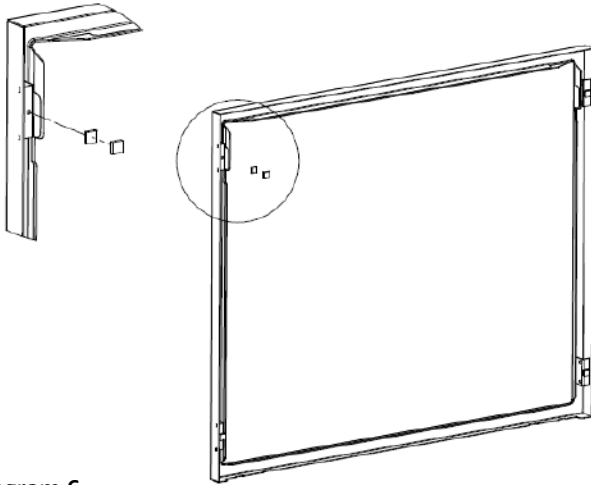

Ensure all the **Magnets** are positioned on the brackets on the rear of the **Trim**.

Note: See P6 for the quantity required - dependant on the model purchased.

See Diagram 6.

Diagram 6

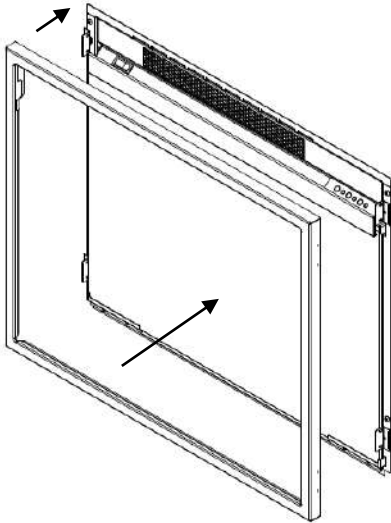

Finally offer the **Trim** up to the **Fire** and centralise.

See Diagram 7.

Diagram 7

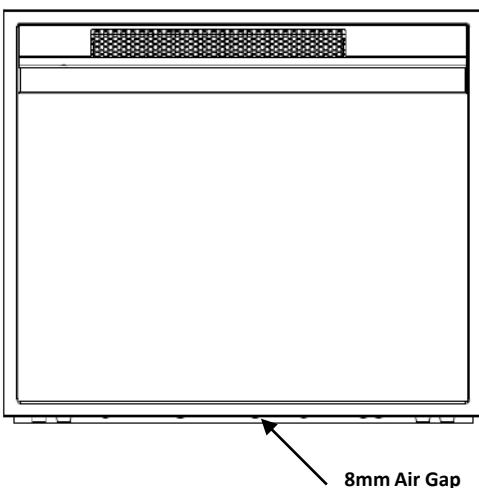

Ensure the 8mm air gap between the bottom of the **Trim** and opening is maintained.

Note: This is critical for correct operation of the **Fire**.

See Diagram 8.

Diagram 8

User Instructions - Introduction

WARNING! Do not operate the appliance if it is damaged or has malfunctioned. If you suspect the appliance is damaged or has malfunctioned call a qualified service engineer to inspect the appliance, and replace any part of the electrical system if necessary, before reuse.

WARNING! To reduce the risk of fire, keep textiles, curtains, or any other flammable material a minimum distance of 1 meter from the air outlet.

MAKE SURE the plug fits tight in the outlet. Faulty wall outlet connections or loose plugs can cause the appliance to overheat.

Do not disconnect the power at the mains supply whilst the appliance is running. Use the functions on the remote or fire to turn the fire off and ensure the mains switch has been moved to the off position before disconnecting.

PREPARATION FOR USE

This appliance can be operated by manual control or remote control. NOTE: To use the appliance the main power switch must be in the 'ON' position.

Batteries

Ensure that the handset batteries are new and inserted correctly.

Main Power Switch

This needs to be switched ON before operating the appliance. A long beep will be heard to indicate the fire is ready for use.

User Instructions – Manual Controls

Switching ON / OFF





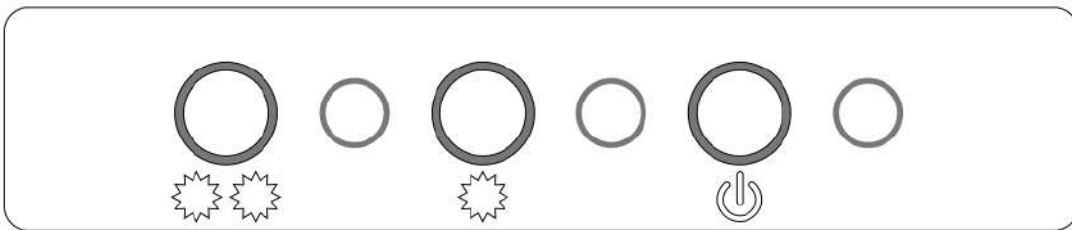

Use the ON / OFF switch to power on the heater (set it to standby mode).

In standby mode, the heater can be operated either manually by the switches located at the front right hand side of heater or by the supplied remote control.

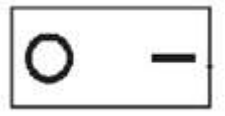
Manual Operation

NOTE: The heater only starts working if the set temperature is higher than the ambient room temperature.



		Heater powered off
		Heater powered on, set to standby mode
		Press to switch the flame effect ON / OFF Press and hold to toggle between 5 different flame dimmer levels
		Press to activate low level heating(1000W)
		Press to activate high level heating(2000W)

User Instructions – Remote Control

Remote Operation

NOTE: The heater should be powered on using the ON/OFF switch before it can be operated using remote control.

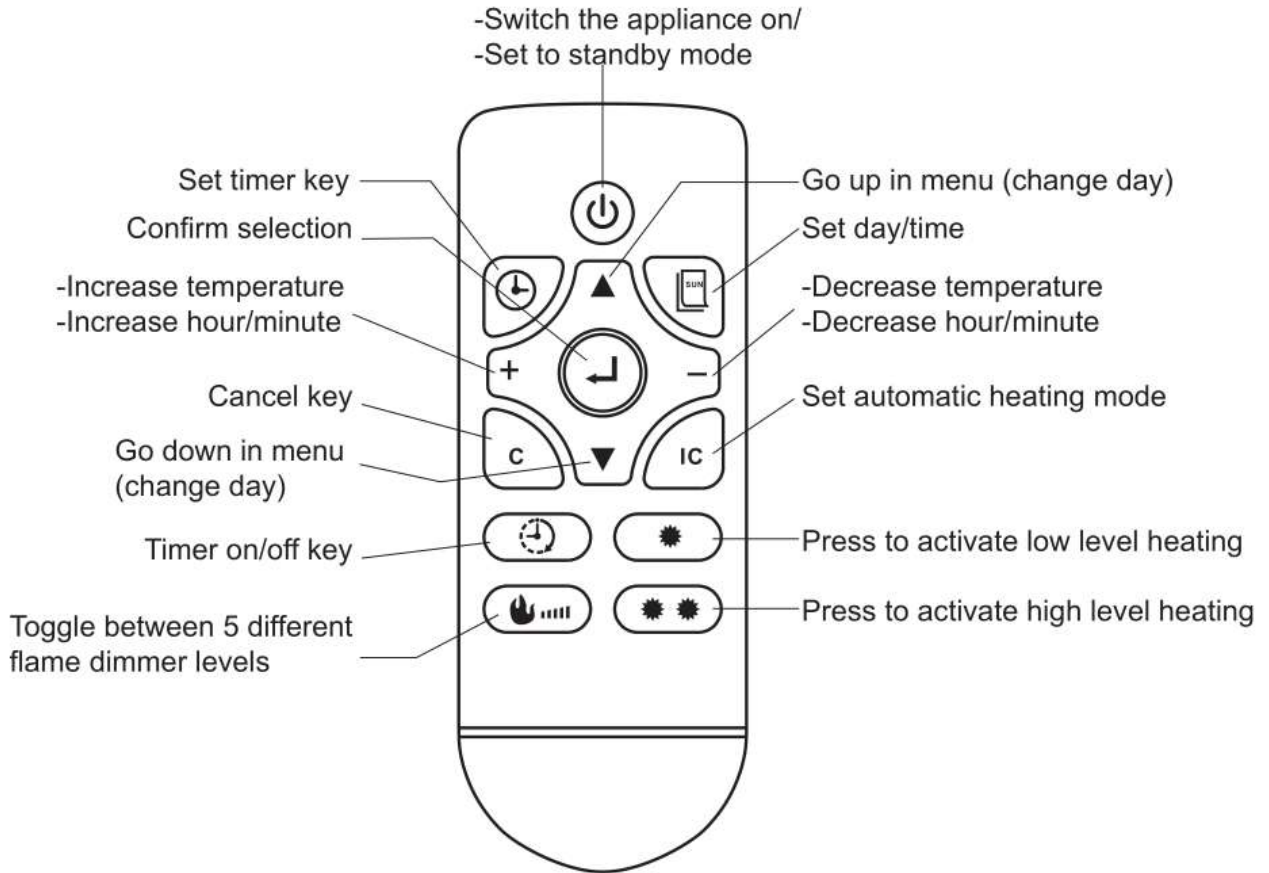

The remote control requires 2xAAA size batteries.

Open the battery compartment by sliding the cover down and insert the batteries noting the polarity indicated in the battery compartment.

Keep batteries out of reach of children.

Remote control operations are identical to the functions on the control panel.

The remote control must be point directly at the sensor on control pad.

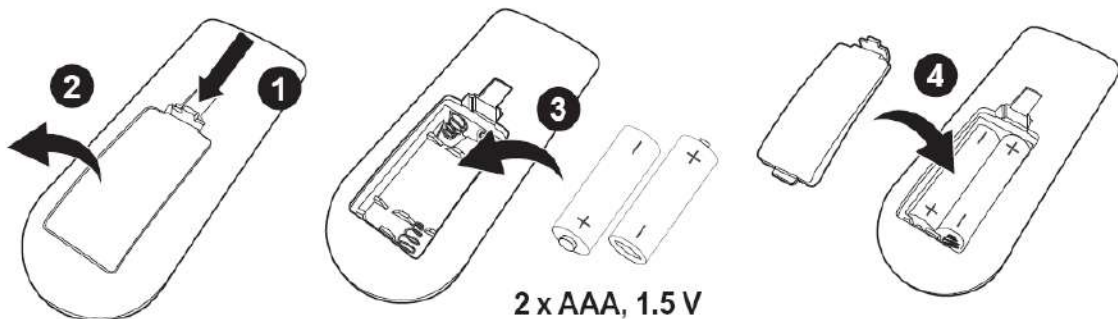

User Instructions – Remote Control *Continued.....*

Display

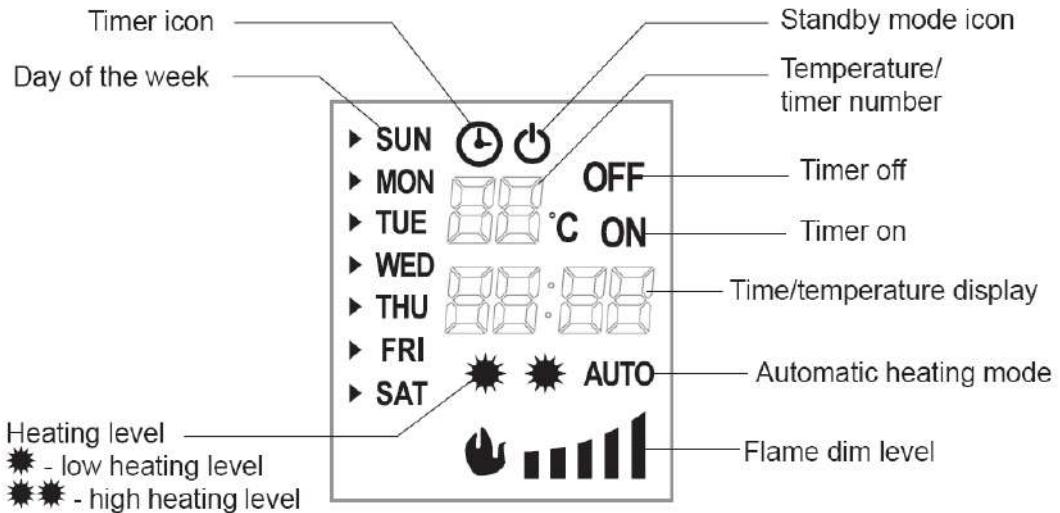



Settings

Setting weekday and time

Press the  key.

When the day is flashing press the ▲ or ▼ key to select the day.

Press the  key again, then press the + or – key to set the hour.

Press the  key again, then press the + or – key to set the minute.

Press the  key to confirm the setting

Setting temperature

NOTE: This setting is only applicable for the temperature in standard heating mode, not for the temperature in the timer mode. **The default set temperature is 20°C.**

NOTE: The heater only starts working when the set temperature is higher than the room temperature.

Press the + or – key to set the temperature, which ranges from 15 to 30°C.

After the temperature setting has been completed, the display flashes about 5 seconds, then shows the room temperature.

User Instructions – Remote Control *Continued.....*

Setting timer

Up to 10 different timer settings can be programmed.
 Each timer setting has its day, power-on time and power-off time.
 The maximum duration of each timer setting is 23 hours 50 minutes.

If the power-off time of the timer setting falls on the following day, it is unnecessary to set the day, just set the power-off time.

Press the  key, the timer numbers will start to blink (01 – 10). Press the + or – key to select a timer number.

Press the  key, the cursor on the left hand side of the day will start to blink

Press the ▲ or ▼ key to move the cursor to the corresponding day.

Press the + key to add a day or press the – key to remove a day.

Press the  key to set the ON time, the hour digit will start to blink. Press the + or – key to set the hour.

Press the  key, the minute digit will start blinking, press the + or – key to set the minute.

Press the  key to set the OFF time, the hour digit will start to blink. Press the + or – key to set the hour.

Press the  key, the minute digit will start blinking, press the + or – key to set the minute.

Press the  key. The temperature digit will start to blink, press the + or – key to set the temperature.

Press the  key to continue with the timer settings or press the  key to confirm the settings.

Viewing the Timer Setting

Press the  key. Press the + or – key to check the power ON time of the set timers one by one.

To check the power OFF time, press the ▲ key. Press the + or – key to check the power OFF time of the set timers one by one. To delete the selected setting, press the C key.

Activation Timer

Press the  key to activate the timer function.

NOTE:- When the timer is active, the heating level must be manually selected. If the heater function is not selected, the flame effect only will come on at the set power ON time.

Automatic Heating Mode

Press the IC key to activate the automatic heating mode. The **AUTO** icon will appear in the display.

When the automatic heating mode is turned ON, the heater automatically changes the heating level depending on the set temperature and the ambient room temperature.

Maintenance

WARNING: Before any maintenance or whilst cleaning the exterior of the fireplace, the unit should be disconnected from the power supply until it has cooled down.

Battery replacement is recommended after 1 year. The batteries are 1.5V alkaline AAA, batteries.

Dispose of old batteries at an appropriate recycling facility.

Cleaning the Fire

Cleaning or polishing products are not recommended.

Fingerprints or other marks on the front glass panel can be removed by a piece of soft, damp, lint-free cloth with a good quality household glass cleaner. The front glass panel should always be completely dried with a clean, lint-free cloth or paper towel.

CAUTION: Abrasive cleaners should not be used on the glass panel. Liquids should not be sprayed directly onto any surface of the unit.

Troubleshooting

Problem	Solution
The fire is not switching on	Ensure the mains switch is on. Replace the fuse in the plug
The fire is not emitting heat	Check the temperature of the fire is set higher than the room temperature
The fire Shuts off after a period of time	The room has reached the set temperature. Has the daily timer been set.
The heater switched off and wont come back on	The safety cut out has operated due to the fire overheating, check inlets and outlets for blockage.
Display showing E1	Fault with temperature sensor either loose or damaged
Display showing E2	Dry or broken solder on track of PCB

Should you be experiencing any problems with your fire please call Customer Services on 01914300901 or email us at customerservices@bemodern.co.uk

General Information

Environment

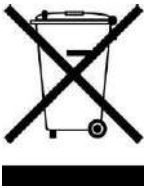

Meaning of crossed –out wheeled dustbin:

Electrical appliances should not be disposed as unsorted municipal waste. Separate collection facilities should be used in the disposal of electrical appliances. Contact your local government for the information about the available collection systems. If electrical appliances are disposed of in landfills or dumps, hazardous substances can leak into the groundwater and get into the food chain, damaging your health and well-being. When old appliances are replaced by the new ones, it is a legal obligation for the retailer to take back the old appliance for disposals at least free of charge.



This fire complies with the Safety Standards EN 60335-1 and EN 60335-2-30 which covers the essential requirements of the Low Voltage Directive 2014/35/EU and the EMC standards EN 55014-1; EN 55014-2; EN 61000-3-2 and EN 61000-3-3 which covers the essential requirements of the European Electro Magnetic Compatibility 2014/30/EU.



This fire complies with the Safety Standards BS 60335-1 and BS 60335-2-30 which covers the essential requirements of the Electrical Equipment (Safety) Regulations 2016 and the EMC standards BS 55014-1; BS 55014-2; BS 61000-3-2 and BS 61000-3-3 which covers the essential requirements of the Electro Magnetic Compatibility Regulations 2016.



RoHS stands for Restriction of Hazardous Substances, and impacts the entire electronics industry and many electrical products as well. The Restrictions of the Use of Certain Hazardous Substances in Electrical and Electronic Equipment Regulations 2012, originated in the European Union in 2002 and restricts the use of six hazardous materials found in electrical and electronic products. All applicable products in the EU and UK market since July 1, 2006 must pass RoHS compliance.