



hunterelectric  
COLLECTION

# ELECTRIC FIREPLACE HEATER OWNER'S MANUAL

**Three Sided Electric Fires**

EF50  
EF60  
EF72

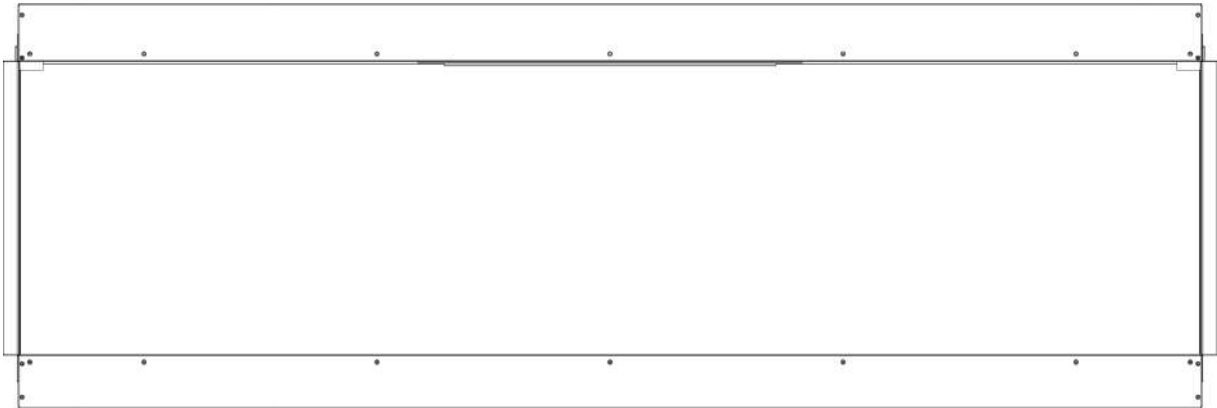

**⚠ WARNING**

Read and understand this entire owner's manual including all safety information, before plugging in or using this product. Failure to do so could result in fire, electric shock, or serious personal injury.

**⚠ CAUTION**

Keep this owner's manual for future reference. If you sell or give this product away, make sure this manual accompanies this product.

# Contents

Parts and Hardware.....	4
Tools Required.....	4
Unpacking and Setup.....	4
Unpacking Instructions.....	4
BOX CONTENTS.....	4
Wiring.....	5
Testing the Fireplace Prior to Installation.....	5
Prong Outlet Installation.....	5
Power Data.....	5
Installation.....	6
WARNINGS.....	6
Choosing Installation Location.....	6
Choosing Wall Location.....	6
How to remove the glass panel bracket.....	6
Recessed Installation.....	7
Instructions:.....	7
Fire Dimensions.....	7
Recessed Installation Overview.....	8
Three-Sided Installation:.....	8
Two-Sided Installation:.....	8
Single-Sided Installation:.....	8
Partial Recess Installation:.....	8
Slide-in cabinet installation:.....	8
Recessed Installation.....	9
Installing the Crystal Ember and Log-set.....	10
Installing the Crystal Embers.....	10
Installing the Log-set.....	10
Reinstalling the Glass Panel.....	10
Operating Fireplace.....	11
Power.....	11
Methods of Operation.....	11
Control Panel.....	11
Wireless Remote Control.....	11
Method of Operation.....	12
Control Panel Functions.....	12
Method of Operation.....	13
Wireless Remote Control Functions.....	13
Remote Control Operation.....	13
Care and Maintenance.....	14
Cleaning.....	14
Maintenance.....	14
Warranty.....	15

# IMPORTANT SAFETY INFORMATION

## WARNING

- **THIS FIREPLACE IS HOT WHEN IN OPERATION AND CAN CAUSE SEVERE BURNS**
- Do not operate fireplace before reading and understanding operation instructions. Failure to operate fireplace according to operation instructions could cause fire or injury.
- Risk of burns. This fireplace is HOT when in operation and heating element is ON. Power to the fireplace should be turned off and the fireplace allowed to cool before servicing. To disconnect power to the fireplace, turn controls to off, then remove plug from outlet.
- Do not install damaged or incomplete, or substitute components.
- Young children should be carefully supervised when they are in same room with fireplace. Toddlers, young children and others may be susceptible to accidental contact burns. A physical barrier is recommended if there are at risk individuals in the house. To restrict access to the fireplace, install an adjustable safety gate to keep toddlers, young children and other at risk individuals away from the fireplace and hot surfaces.
- Clothing and other flammable material should not be placed on or near the fireplace.
- Due to high temperatures, the fireplace should be located out of traffic and away from furniture and draperies.
- Ensure that you have incorporated adequate safety measures to protect infants/toddlers from touching hot surfaces.
- It is imperative that the control compartments, circulating blower, and its passageway is kept clean.
- Under no circumstances should this fireplace be modified.
- Do not use the fireplace if any part has been under water.
- Do not operate the fireplace with the glass panel removed, cracked or broken.
- Keep the packaging material out of the reach of children. As with all plastic bags, these are not toys and should be kept away from children and infants.
- Servicing should only be done while the fireplace is disconnected from the power outlet.
- Unplug fireplace if not being used for an extended period of time.
- Do not operate this fireplace with a damaged cord or plug after the fireplace malfunctions, has been dropped, or damaged in any manner.
- Do not use outdoors.
- Never locate fireplace where it may fall into a bathtub or other water container.
- Do not run the cord under carpeting. Do not cover cord with throw rugs, runners, or the like. Arrange cord away from traffic area and where it will not be tripped over.
- Connect to properly grounded outlets only.
- Do not insert foreign objects into any ventilation or exhaust opening as this may cause an electric shock, fire, or damage to the fireplace.
- To prevent a possible fire, do not block the air intakes or exhaust in any manner. Do not use on soft surfaces, like a carpet, where openings may be blocked.
- Ensure clearances to combustibles are maintained when building a mantel or shelves above the fireplace. Elevated temperatures on the wall or in the air above the fireplace can cause melting, discoloration or damage to the decorations, a TV or other electronic components.

# Parts and Hardware

## Tools Required

- Phillips screwdriver
- Stud finder
- Level
- Tape measure
- Electric drill
- Wood drill bit









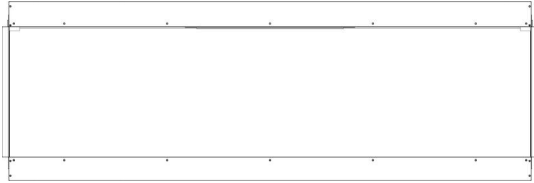

## Unpacking and Setup

### Unpacking Instructions

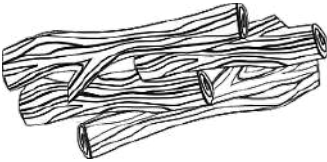
- Remove all parts and hardware from the carton and place them on a clean, soft, dry surface. Check the parts list to make sure no parts are missing. If parts are missing, please contact technical support for replacement parts.

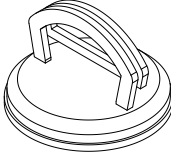
**NOTE: Dispose of plastic bag, as it may cause choking hazard with young children. Do not let children play with plastic bag.**

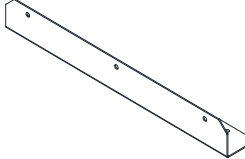
### BOX CONTENTS

		
1 Fireplace		
		
Front Glass	2 Side Glass Pieces	1 Remote Control
		
Canyon Driftwood Logs	Crystal Embers	Sucker
		
2 Side Covers	Metal Bracket	Screws

# Wiring

The HM series recessed fireplace can be plugged into a grounded 3-prong outlet.

## Testing the Fireplace Prior to Installation

- Before installing the fireplace, test the fireplace to make sure that it operates properly. Due to the motor the fire will have a slight noise when in operation
- The remote will need syncing to the fire unit. This can be done in either of two ways.  
1: when plugging the fire in for the first time you need to use the remote rather than the buttons on the unit. When first plugged in you should see an orange light come on and whilst this is on you tap the red power button at the top of the remote several times and this will sync the remote. If the fire is already plugged in – you can unplug the fire, leave the fire off for 20 seconds and try the above again.

OR

2: When the fire is plugged in turn on the fire using the red button on the fire. Then whilst the fire is on hold down the red button on the unit for 3-4 seconds and this should bring the orange light on and then tap the red power button at the top of the remote several times to sync.

## Prong Outlet Installation

- Only use this fireplace on a 230V ac, 7.5-Amp grounded circuit. Never overload the circuit. If this fireplace trips the circuit breaker, unplug all other appliances on the same circuit before the next use. Avoid plugging other appliances into the same circuit as this fireplace.
- Always check the fireplace plug and connections before each use.
- Never plug this fireplace into an outlet that is cracked or has any loose wires or connections. Plugging this fireplace into a faulty outlet could result in the outlet overheating or catching fire.
- Make sure this plug fits securely into the outlet. Faulty wall outlet connections or loose plugs can cause the outlet to overheat. If the outlet or face plate is hot, discontinue use immediately and have a qualified electrician inspect and/or replace the faulty outlet.

## Power Data

Model	EF50	EF60	EF72
Voltage	230Vac	230Vac	230Vac
Watts	1500W	1500W	1500W
Amps	7.5AMP	7.5AMP	7.5AMP

# Installation

## WARNINGS

- Due to high temperatures, keep the fireplace out of high traffic locations.
- Keep combustible materials, such as furniture, pillows, bedding, papers, clothes, and curtains at least 1M away from the front of the fireplace.
- Never install the fireplace where it may fall into a bathtub or other body of water.
- Wear safety gloves and safety glasses for protection during installation. Broken glass may cause injury or harm.
- Prevent contact with loose insulation. Do not install the fireplace against a vapor barrier or exposed insulation.
- Do not expose the fireplace to the elements (rain, etc).

## Choosing Installation Location

### Choosing Wall Location

- Measure wall location to ensure that fireplace will fit on desired wall location.
- Minimum clearances (measurements taken from front of glass panel):

<b>Bottom of Fireplace to Floor:</b> 150mm	<b>Top of Fireplace:</b> 200mm to mantel
<b>Sides of Fireplace:</b> 0mm	<b>Top of Fireplace:</b> 200mm to TV
<b>Back of Fireplace:</b> 0mm	<b>Top of Fireplace:</b> 200mm to ceiling

- Select a location that is not prone to moisture and is located at least 1000mm away from combustible materials such as curtains, drapes, furniture, bedding, or other combustible materials.
- See Safety Information for warnings about safe placement, safe installation, and proper use of this product.

## How to remove the glass panel bracket

1. There are 4 screws that fasten the glass panel bracket to the fireplace. Remove all 4 screws to remove the glass panel bracket.
2. After removing screws, the glass panel bracket away from the fireplace.

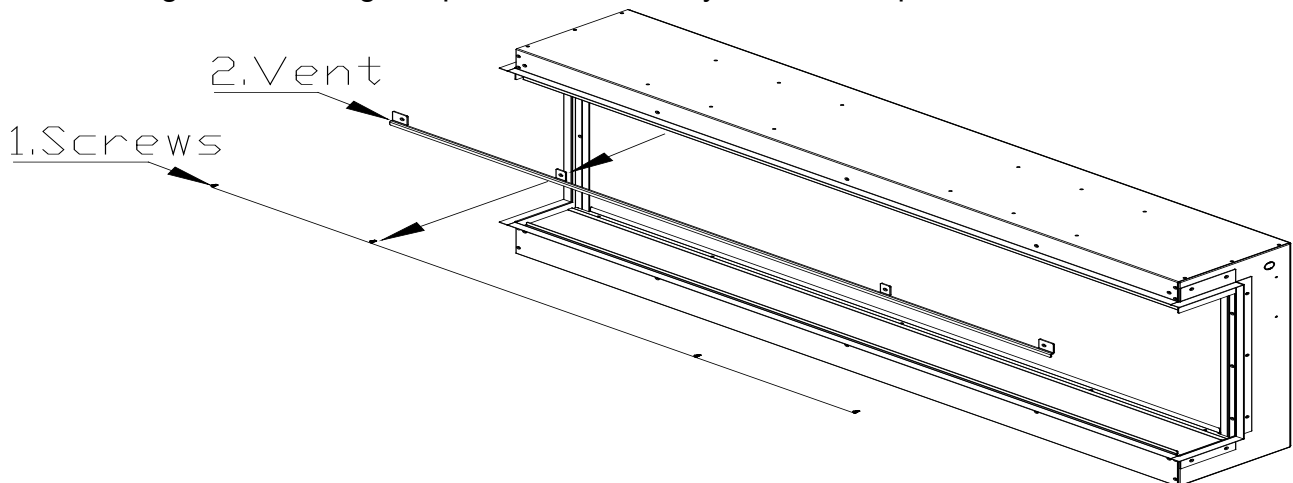

## Recessed Installation

- Due to many different finish materials used on walls, it is highly recommended that you consult your local builder before you install this fireplace in the wall.
- Select a location that is not prone to moisture and is located at least 1000mm away from combustible materials such as curtains, drapes, furniture, bedding, or other combustible materials.
- In order to avoid the possibility of exposed insulation or vapor barrier coming in contact with the fireplace, it is recommended that the walls of the fireplace enclosure be “finished” (ie. Sheetrock, drywall, etc) as you would finish any other outside wall of your home. This will ensure that clearance to combustibles is maintained within the wall cavity.
- Never install fireplace into load-bearing walls. When recessing fireplace in a wall, recess into non-load bearing walls ONLY!

### Instructions:

1. Choose a location in the wall to install fireplace.
2. Make an opening in the wall based on metal firebox size.

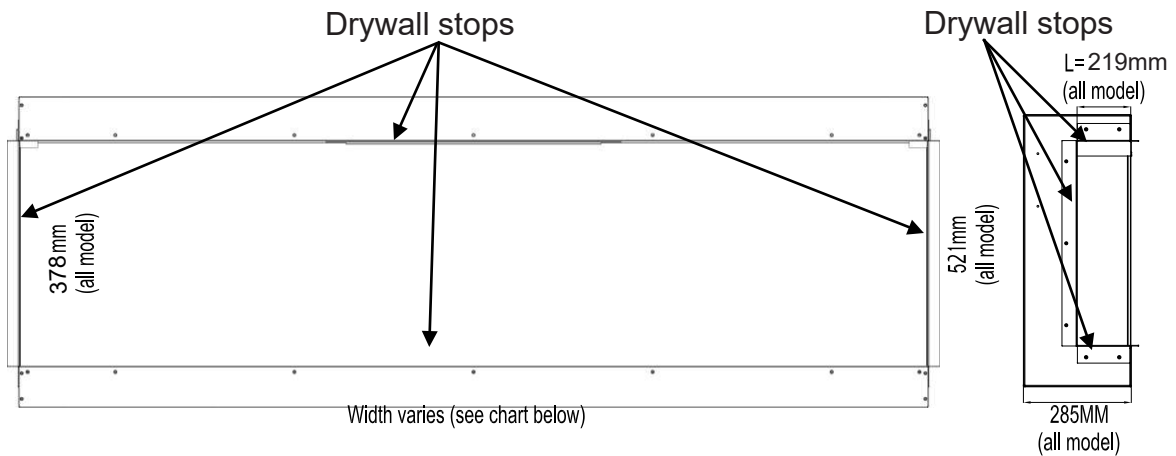

### Fire Dimensions

Model	EF50	EF60	EF72
Fireplace Height Overall	521mm	521mm	521mm
Fireplace Height Recess	521mm	521mm	521mm
Fireplace Width Overall	1296mm	1550mm	1826mm
Fireplace Width Recess	1270mm	1524mm	1800mm
Fireplace Depth Overall	296mm	296mm	296mm
Fireplace Depth Recess	285mm	285mm	285mm

## Recessed Installation Overview

The HM three-sided Electric Fireplace can be installed in five different recessed configurations:

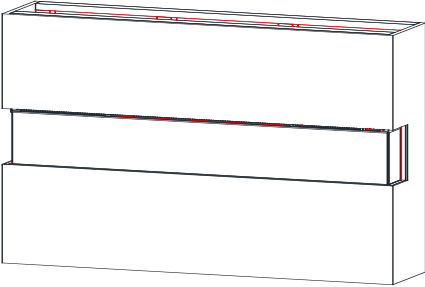
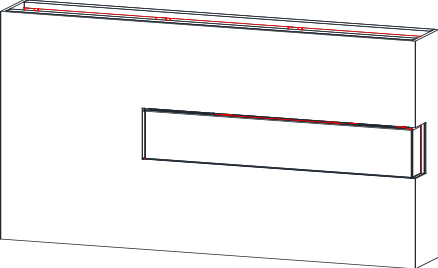
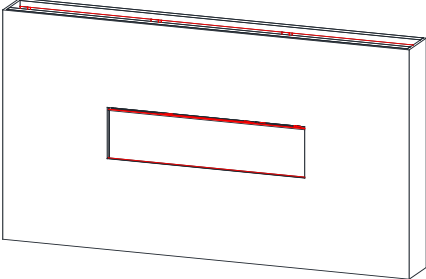
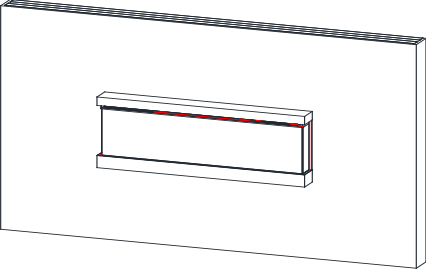
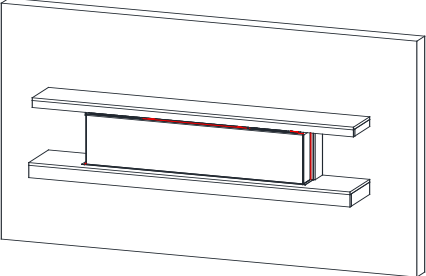
 A perspective diagram showing a fireplace unit fully recessed into a wall. The top, left, and right sides of the unit are flush with the wall, while the front face is exposed.	<p><b>Three-Sided Installation:</b></p> <ul style="list-style-type: none"><li>• Glass exposed on the left, front, and right sides</li><li>• Fireplace is fully recessed into the wall with both sides open</li></ul>
 A perspective diagram showing a fireplace unit recessed into a wall. The top and left sides are flush with the wall, while the front and right sides are exposed.	<p><b>Two-Sided Installation:</b></p> <ul style="list-style-type: none"><li>• Glass exposed on the front and left or right side.</li><li>• Fireplace is fully recessed into the wall with one side open.</li></ul>
 A perspective diagram showing a fireplace unit recessed into a wall. The top, left, and right sides are flush with the wall, and only the front face is exposed.	<p><b>Single-Sided Installation:</b></p> <ul style="list-style-type: none"><li>• Glass exposed in the front of the fireplace.</li><li>• Fireplace is fully recessed into the wall.</li></ul>
 A perspective diagram showing a fireplace unit partially recessed into a wall. The top and left sides are flush with the wall, while the front and right sides are exposed.	<p><b>Partial Recess Installation:</b></p> <ul style="list-style-type: none"><li>• Glass exposed on the left, front, and right sides</li><li>• Fireplace is fully recessed into the wall with both sides open</li></ul>
 A perspective diagram showing a fireplace unit installed within a cabinet. The unit is recessed into the wall, with the cabinet's top and bottom shelves visible on either side.	<p><b>Slide-in cabinet installation:</b></p> <ul style="list-style-type: none"><li>• Glass exposed on the left, front, and right sides</li><li>• Fireplace is fully recessed into the wall with both sides open</li></ul>



# Recessed Installation

## Three-Sided Installation:

1. Prepare the framed opening according to the Rough Opening Dimensions chart. Provide a 230Vac 13amp circuit for wire install at the top right of the framed opening.
2. Install Metal Bracket.
3. Install the fire unit in the framed opening with a minimum 1 ¼ drywall screws to secure the unit.
4. Mask the exposed fire unit during the drywall process. Install drywall to the drywall stops on the perimeter of the fire box.

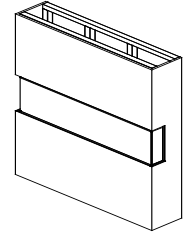
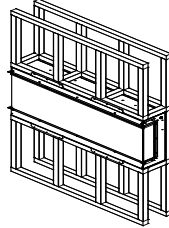
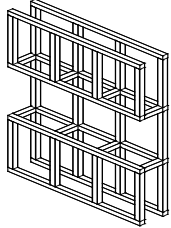

## Two-Sided Installation:

1. Follow steps 1 & 2 from the three-sided installation instructions.
2. Remove the corresponding drywall stops according to your installation (in the example, the drywall stops on the left end would be removed.)
3. Install the side glass then the corresponding side cover according to your installation (the side glass must be installed before the metal side cover.)
4. Install the fire unit in the framed opening with a
5. minimum 1 ¼ drywall screws to secure the unit.
6. Mask the exposed fire unit during the drywall process. Install drywall to the drywall stops on the perimeter of the fire box.

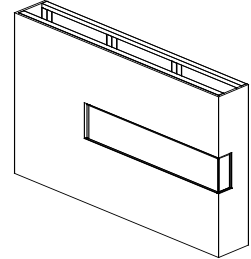
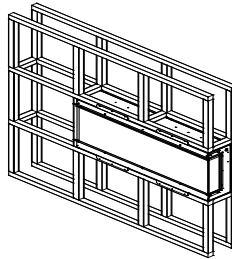
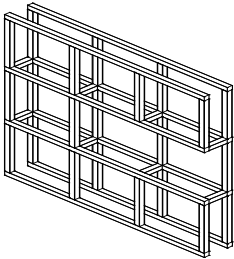

## Single-Sided Installation:

1. Follow steps 1 & 2 from the three-sided installation instructions.
2. Remove the drywall stops on both sides of the fire unit.
3. Install the side glass then side covers on both sides of the fire unit.
4. Install the fire unit in the framed opening with a minimum 1 ¼ drywall screws to secure the unit.

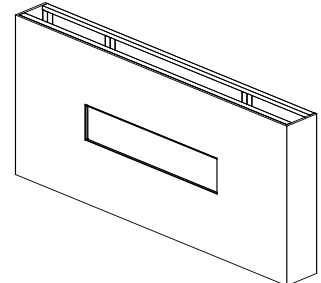
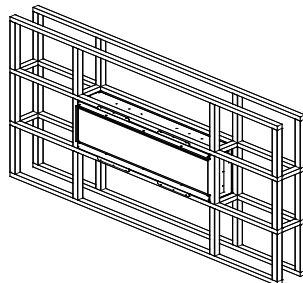
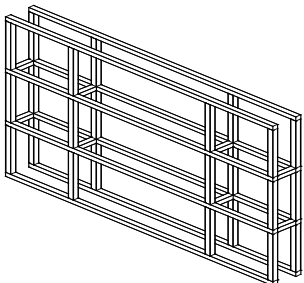

### Partial Recess Installation (Optional):

Follow the directions included with the Partial Recess.

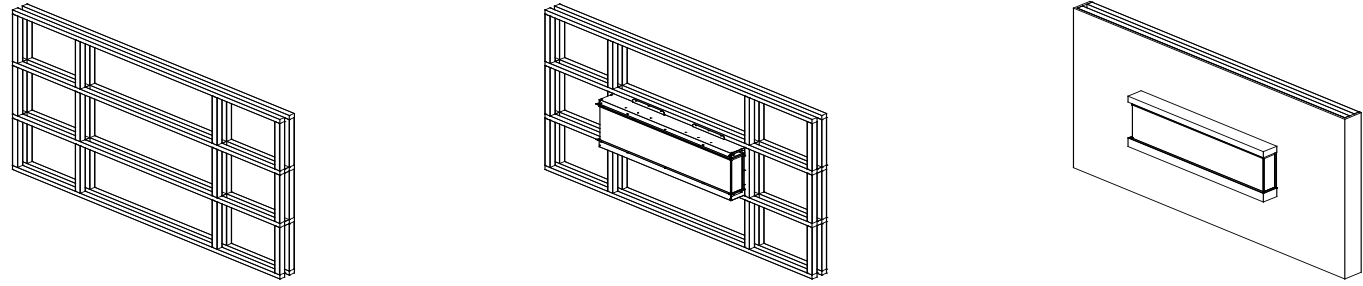

### Slide-in cabinet installation (Optional):

Follow the directions included with the Slide-in Cabinet.

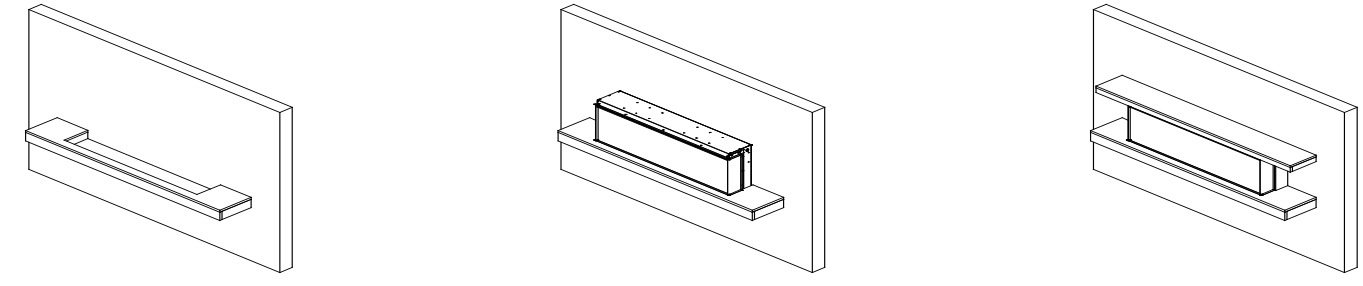

## Installing the Crystal Ember and Log-set

Once the fireplace is installed in the wall, place crystal media stones and artificial logs in the fireplace.

### Installing the Crystal Embers

1. Carefully place crystal embers on plastic strip. Apply an even layer from side to side. Randomly place the crystals on top of the crystals to add an extra dimension to the ember bed.

### Installing the Log-set

1. Carefully place the log set in the designed ember slot.

## Reinstalling the Glass Panel

Once completed installing crystal embers or fire log, you are now ready to reinstall the glass panel.

1. Place the glass panel back inside the fireplace and push the glass panel into place.
2. Reattach the screws holding the glass panel in place, as shown below.

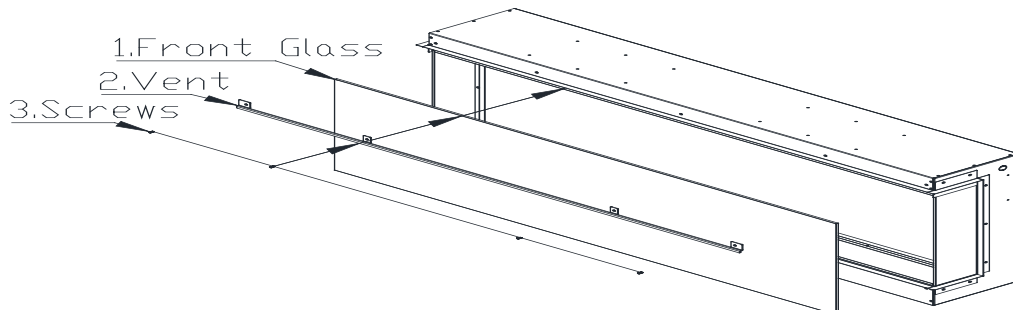

Your HM Series fireplace is now ready for use!

# Operating Fireplace

Once the fireplace has been plugged into a grounded outlet, the fireplace is now ready for operation. Ensure that the house circuit breakers for the power supply are turned on.

## Power

Plug the power cable into a 230v 7.5 amp grounded outlet. Make sure the outlet is in good condition and that the plug is not loose. **NEVER** exceed the maximum amperage for the circuit. **DO NOT** plug other appliances into the same circuit.

## Methods of Operation

This electric fireplace can be operated by the CONTROL PANEL, located in the upper right hand corner of the fireplace, or by the WIRELESS REMOTE CONTROL. The operation and functions of both methods are the same.

### Control Panel

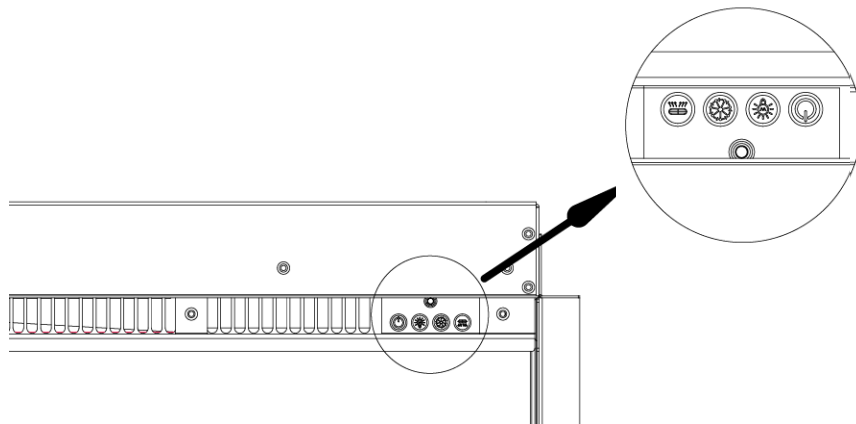

### Wireless Remote Control







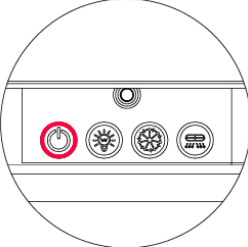
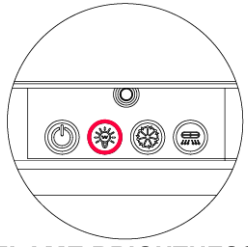
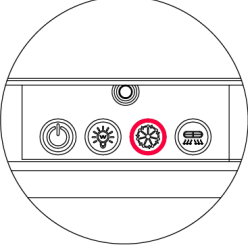
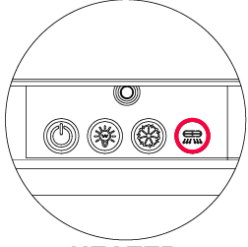
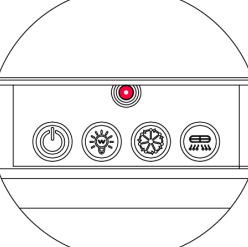





# Method of Operation

## Control Panel Functions

BUTTON	FUNCTION	ACTION & INDICATION
 <p><b>POWER</b></p>	<p><b>ON:</b> Enables control panel functions and remote control. Turns on flame effect.</p> <p><b>OFF:</b> Disables control panel functions and remote control. Turns off flame effect.</p>	<ol style="list-style-type: none"> <li><b>Press once.</b> Indicator light turns on. Power turns on. All functions enabled.</li> <li><b>Press again.</b> Flame effect turns off. Unit goes to standby. All functions turn off.</li> </ol>
 <p><b>FLAME BRIGHTNESS</b></p>	<p><b>Flame button:</b> Each press of the flame button makes flame effect dimmer and brighter.</p> <p><b>NOTE:</b> Flame effect stays on until power button is turned off. Flame effect must be on for heater to turn on.</p>	<ol style="list-style-type: none"> <li><b>Press once</b> to change the flame brightness.</li> <li><b>Press again</b> until desired flame brightness setting is reached.</li> </ol>
 <p><b>FLAME COLOR</b></p>	<p><b>Flame Color button:</b> Changes the color flame effect.</p> <p><b>NOTE:</b> Color effect stays on until power button is turned off. <b>NOTE:</b> The fireplace will remember the last flame color used when the fireplace is turned off. Unplugging the fireplace will reset the color to the default color.</p>	<ol style="list-style-type: none"> <li><b>Press once</b> to change the flame color.</li> <li><b>Press again</b> until desired setting is reached. There is a total of 8 different flame color combinations.</li> </ol>
 <p><b>HEATER</b></p>	<p><b>Heater button:</b> Turns heater on and off.</p> <p><b>NOTE:</b> The heater only works when the flame effect is ON. If the flame effect is OFF, the heater will not turn on.</p> <p><b>NOTE:</b> To prevent overheating, the heater blows cool air for 30 seconds after it turns off.</p>	<ol style="list-style-type: none"> <li><b>Press once.</b> Indicator lights up. Low heater turns on and blows warm air.</li> <li><b>Press again.</b> Indicator lights up. High heater turns on and blows hot air.</li> <li><b>Press again.</b> Heaters turn off. The fan blows cool air for 30 seconds and then turns off.</li> </ol>
 <p><b>RESET</b></p>	<p><b>Reset button:</b> Reset to default state.</p>	<ol style="list-style-type: none"> <li><b>Press 3S.</b> Reset to default state.</li> </ol>

## Method of Operation

### Wireless Remote Control Functions

	Power button	The machine can be turned on and off cyclically
	Color ring	Adjustable global or single group color
	Dimmer	Adjustable global or single group brightness
	Flame selection button	After selection, you can adjust the flame color, brightness and mode
	Ambient Light selection button	After selection, you can adjust the ambient light color, brightness
	Ember bed light selection button	After selection, you can adjust the ember bed light color, brightness
	Mode button	Adjustable global or single group light flashing mode
	Timer button	1-9H timer setting
	Heater	Heater switch low-high-off continuous cycle
	Sound button	Crackle sound ON/OFF
	Reset	Reset to default state



## Remote Control Operation

- This remote control uses 1 CR2025 batteries
- To improve operation of the remote control, aim the remote control at the front of the fireplace. **DO NOT PRESS the buttons too quickly.** Give the unit time to respond to each command.
- **NOTICE: NEVER** dispose of batteries in fire. Failure to observe this precaution **may result in an explosion.** Dispose of batteries at your local hazardous material processing center.

# Care and Maintenance

## Cleaning

- **ALWAYS** turn the heater **OFF** and unplug the power cord from the outlet before cleaning, performing maintenance, or moving the fireplace. Failure to do so could result in electric shock, fire, or personal injury.
- **NEVER** immerse in water or spray with water. Doing so could result in electric shock, fire, or personal injury.

### Metal:

- Buff using a soft cloth, slightly dampened with citrus oil-based product.
- **DO NOT** use brass polish or household cleaners, as these products will damage the metal trim.

### Glass:

- Use a good quality glass cleaner sprayed onto a cloth or towel. Dry thoroughly with a paper towel or lint-free cloth.
- **NEVER** use abrasive cleansers, liquid sprays, or any cleaner that could scratch the surface.

### Vents:

- Use a vacuum or duster to remove dust and dirt from the heater and vent areas.

### Plastic:

- Wipe gently with a slightly damp cloth and a mild solution of dish soap and warm water.
- **NEVER** use abrasive cleansers, liquid sprays, or any cleaner that could scratch the surface.

## Maintenance

- **RISK OF ELECTRIC SHOCK! DO NOT OPEN any panels. No user-serviceable parts inside!**
- **ALWAYS** turn the heater **OFF** and unplug the power cord from the outlet before cleaning, performing maintenance, or moving the fireplace. Failure to do so could result in electric shock, fire, or personal injury.

### Electrical and Moving Parts:

- The fan motors are lubricated at the factory and will not require lubrication.
- Electrical components are integrated in the fireplace and are not serviceable by the customer.

### Storage:

- Store fireplace in a clean, dry place when not in use.

## Warranty

Our electric fireplaces are to be free of defects in material and workmanship for one year from the date of purchase. This warranty only covers manufacturing faults.

This warranty does not cover damages, accidents, lack of maintenance, abuse or neglect. The warranty does not cover paint scratches, cosmetic blemishes, dents, corrosion or other normal wear and tear associated with the fireplace. Damage to the fire or other components due to water, weather damage, long periods of dampness or condensation. Damaging chemicals or cleaners are not covered under warranty.

This warranty does not cover breakage of the fireplace glass panel.

Affix Serial Number Label Here